

**INSTRUCTION  
MANUAL**

# ATyS *p* M

Automatic Transfer Switching Equipment

**EN**





[www.socomec.com](http://www.socomec.com)

[www.socomec.com/en/atys-p-m](http://www.socomec.com/en/atys-p-m)

To download, brochures, catalogues and technical manuals :

This manual is available for download in French, English, German, Italian, Spanish, Dutch, Portuguese, Russian, Polish, Turkish and Chinese.

# INDEX



1. GENERAL SAFETY INSTRUCTIONS .....	6
2. INTRODUCTION.....	7
2.1. THE ATYS FAMILY PRODUCT RANGE .....	7
2.2. THE ATYS M RANGE KEY FEATURES .....	8
2.2.1. SELECTION GUIDE .....	9
3. QUICK START .....	10
3.1. QUICK START ATYS P M .....	10
4. ATYS P M VERSIONS .....	14
4.1. PRODUCT PRESENTATION .....	14
4.2. SPECIFICATIONS AND ADVANTAGES .....	14
4.3. SUPPLY TYPES.....	14
5. OPTIONAL ACCESSORIES .....	15
6. TECHNICAL DATA.....	16
7. ENVIRONMENTAL CONDITIONS .....	17
8. PRODUCT INSTALLATION .....	18
8.1. CHANGING THE PADLOCKING CONFIGURATION .....	18
8.2. RECOMMENDED ORIENTATION .....	18
8.3. DIMENSIONS.....	18
8.4. BACK PLATE MOUNTED .....	18
8.5. DIN RAIL MOUNTED .....	19
9. INSTALLATION OF OPTIONAL ACCESSORIES.....	20
9.1. AUXILLIARY CONTACTS .....	20
9.2. VOLTAGE SENSING AND POWER SUPPLY TAP .....	20
9.3. BRIDGING BARS 4P .....	20
9.4. TERMINAL SHROUDS.....	21
10. INSTALLING WITHIN THE ATYS M ENCLOSURE .....	22
10.1. POLYCARBONATE ENCLOSURE .....	22
10.1.1. WIRING IN A POLYCARBONATE ENCLOSURE .....	22
10.1.2. EXTENSION UNIT .....	22

<b>11. CONNECTION OF THE POWER CIRCUITS</b> .....	23
11.1. RATINGS / CROSS-SECTIONS TABLE OF CORRESPONDENCE.....	23
11.2. PARALLEL POLE SET-UP FOR A 4P DEVICE USED IN SINGLE PHASE.....	23
11.3. NETWORK CONFIGURATIONS.....	24
11.3.1. VOLTAGE CONFIGURATIONS.....	24
11.3.2. CONFIGURATION DE LA TENSION POUR LES VERSIONS 127/230VAC.....	26
11.3.3. THREE PHASE WITHOUT NEUTRAL NETWORK.....	28
<b>12. CONNECTION OF CONTROL/COMMAND CIRCUITS</b> .....	29
12.1. TERMINAL CONNECTORS DESIGNATION.....	30
12.2. AUXILIARY CONTACT OPERATING SCHEDULE.....	30
<b>13. OPERATION</b> .....	31
13.1. PRESENTATION OF THE PRODUCT INTERFACE.....	31
13.1.1. RESET.....	32
13.2. MANUAL MODE.....	32
13.2.1. MANUAL SWITCHING.....	32
13.3. PADLOCKING.....	33
13.4. FRONT KEYPAD NAVIGATION AND GENERAL INFORMATION.....	34
13.4.1. KEYPAD.....	34
13.4.2. SOFTWARE VERSION.....	34
13.4.3. DISPLAY PRESENTATION.....	34
13.4.4. EVENTS.....	35
13.4.5. EVENTS LIST.....	35
13.5. PROGRAMMING.....	37
13.5.1. PROGRAMMING WITH EASYCONFIG.....	37
13.5.2. PRODUCT PROGRAMMING WITH THE FRONT KEYPAD.....	37
13.5.3. PROGRAMMING MODE.....	38
13.5.4. SETUP MENU.....	40
13.5.5. PHASE ROTATION CHECK.....	42
13.5.6. VOLT. LEVELS MENU.....	43
13.5.7. OVER-VOLTAGE AND UNDER-VOLTAGE.....	44
13.5.8. FREQ. LEVELS MENU.....	45
13.5.9. TIMERS MENU.....	46
13.5.10. I-O MENU.....	48
13.5.11. COMM MENU.....	53
13.6. AUTOMATIC MODE.....	54
13.6.1. SEALABLE AUTO/MANUAL COVER.....	54
13.6.2. POSSIBLE ACTIONS.....	54
13.6.3. PRIORITY SOURCE LOSS SEQUENCE (STABLE POSITION) IN M-G APPLICATION.....	55
13.6.4. PRIORITY SOURCE LOSS AND RESTORATION SEQUENCE (STABLE POSITION) IN M-M APPLICATION.....	56
13.6.5. PRIORITY SOURCE LOSS SEQUENCE (WITH TRIP) IN M-M APPLICATION.....	57
13.6.6. PRIORITY SOURCE LOSS SEQUENCE (WITH TRIP) IN M-G APPLICATION.....	58
13.6.7. PRIORITY SOURCE AUTOMATIC RESTORATION SEQUENCE.....	59
13.6.8. PRIORITY SOURCE RESTORATION SEQUENCE (STABLE POSITION) IN M-G APPLICATION.....	60

13.6.9. BACK-UP SOURCE LOSS SEQUENCE (WITH TRIP) IN M-G APPLICATION .....	.61
<b>13.7. CONTROL / TEST OPERATING MODE .....</b>	<b>.62</b>
13.7.1. TEST MODES .....	.62
13.7.2. OFF LOAD TEST (M-G APPLICATION ONLY) .....	.62
<b>13.8. EMERGENCY BREAKING (TRIP FUNCTION) .....</b>	<b>.64</b>
<b>13.9. COMMUNICATION (OPTIONAL 9383 XXXX UNITS ONLY) .....</b>	<b>.65</b>
13.9.1. COMM MENU .....	.65
13.9.2. GENERAL INFORMATION .....	.65
13.9.3. MODBUS® PROTOCOL .....	.66
13.9.4. FUNCTION 3 .....	.67
13.9.5. FUNCTION 6 .....	.69
13.9.6. FUNCTIONS 3, 6 AND 16 .....	.70
<b>14. PREVENTATIVE MAINTENANCE .....</b>	<b>.73</b>
<b>15. TROUBLESHOOTING GUIDE .....</b>	<b>.74</b>

# 1. GENERAL SAFETY INSTRUCTIONS

- This manual provides instructions on safety, connections and operation of the ATyS M transfer switch manufactured by SOCOMEC.
- Whether the ATyS is sold as a loose product, as a spare, as an enclosed solution or as any other configuration, this device must always be installed and commissioned by qualified and experienced personnel, in line with the manufacturers recommendations, following good engineering practices and after having read and understood the details in the latest release of the relative product instruction manual.
- Maintenance on the product and any other associated equipment including but not limited to servicing operations must be performed by adequately trained and qualified personnel.
- Each product is shipped with a label or other form of marking including rating and other important specific product information. One must also refer to and respect markings on the product prior to installation and commissioning for values and limits specific to that product.
- Using the product outside the intended scope, outside SOCOMEC recommendations or outside the specified ratings and limits can cause personal injury and/or damage to equipment.
- This instruction manual must be made accessible so as to be easily available to anyone who may need to read it in relation with the ATyS.
- The ATyS meets the European Directives governing this type of product and includes CE marking on each product.
- No covers other than that for auto/manu on the ATyS should be opened (with or without voltage) as there may still be dangerous voltages inside the product such as those from external circuits.
- **Do not handle any control or power cables connected to the ATyS when voltage may be present on the product directly through the mains or indirectly through external circuits.**
- Voltages associated with this product may cause injury, electric shock, burns or death. Prior to carry out any maintenance or other work on live parts or other parts in the vicinity of exposed live parts, ensure that the switch including all control and associated circuits are de-energized.

 <b>DANGER</b>	 <b>WARNING</b>	 <b>CAUTION</b>
<b>RISK:</b> Electric shock, burns, death	<b>RISK:</b> Possible personal injury	<b>RISK:</b> Equipment damage

- As a minimum the ATyS M comply with the following international standards:
  - IEC 60947-6-1
  - GB 14048-11
  - EN 60947-6-1
  - VDE 0660-107
  - BS EN 60947-6-1
  - NBN EN 60947-6-1
  - IEC 60947-3
  - IS 13947-3
  - EN 60947-3
  - NBN EN 60947-3
  - BS EN 60947-3

The information provided in this instruction manual is subject to change without notice, remains for general information only and is non-contractual.

## 2. INTRODUCTION

ATyS p M “Automatic Transfer Switching Equipment” (ATSE) is designed for use in power systems for the safe transfer of a load supply between a normal and an alternate source. The changeover is done in open transition and with minimum supply interruption during transfer ensuring full compliance with IEC 60947-6-1, GB 14048-11 and other international TSE standards as listed.

The ATyS p M is a full load break (switch type) derived transfer switching equipment where the main components are proven technology devices also fulfilling requirements in IEC 60947-3 standards.

As a Class PC ATSE, the ATyS p M is capable of “making and withstanding short circuit currents” assigned to IEC 60947-3 utilization categories of up to AC23A, GB 14048-11, IEC 60947-6-1 and equivalent standards with utilization categories of up to AC33B.

### ATyS p M transfer switches ensure:

- Power Control and Safety between a normal and an alternate source.
- A complete product delivered as a fully assembled and tested solution.
- Intuitive HMI for emergency / local operation.
- Integrated and robust switch disconnection.
- Window with clearly visible position indication I – 0 - II.
- An inherent failsafe mechanical interlock.
- Stable positions (I – 0 – II) non affected by typical vibration and shocks.
- Constant pressure on the contacts non affected by network voltage.
- Energy Efficient with virtually no consumption whilst on the normal, alternate or off positions.
- Extremely rugged, error free and built in padlocking facility (configurable).
- Straight forward installation with effective ergonomics.
- Programmable secure motorization controls interface.
- User configurable I/O with communication through Modbus® (RS485) Optional
- ATS configuration through a keypad as well as through EasyConfig programming software.
- Auxiliary contacts for switch positions I – 0 - II (optional).
- “Product availability” output.
- Ample accessories to suit specific requirements.
- Fully integrated ATS controller specifically designed for Mains / Mains and Mains / Genset applications.

### 2.1. The ATyS family product range

Just the right ATyS for your application...

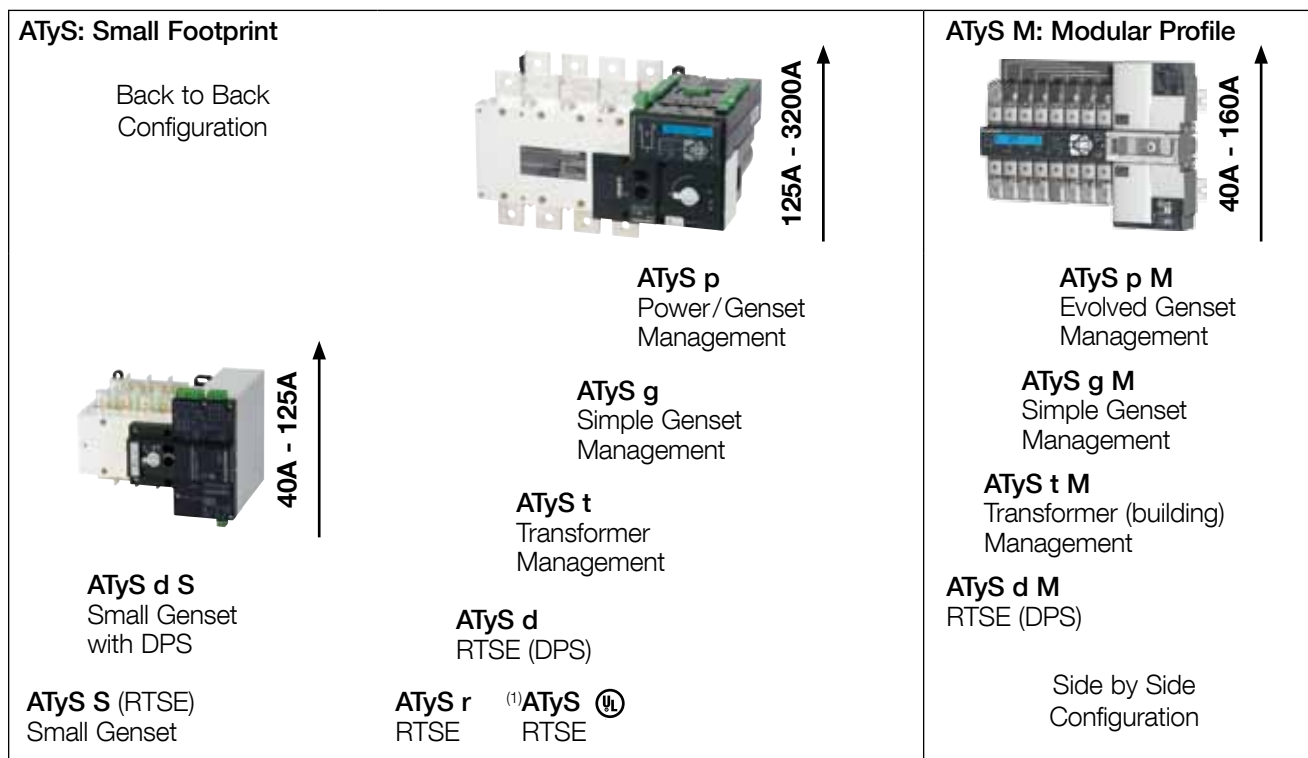

<sup>(1)</sup> The UL version of ATyS r is available from 100 - 400A

## 2.2. The ATyS M Range Key Features

Selecting the right ATyS M will depend on the application, the functionality required as well as the nature of the installation in which the ATyS M will be installed. Below is an outline product selection chart listing the key features of each product to help you select the right ATyS M for your needs.

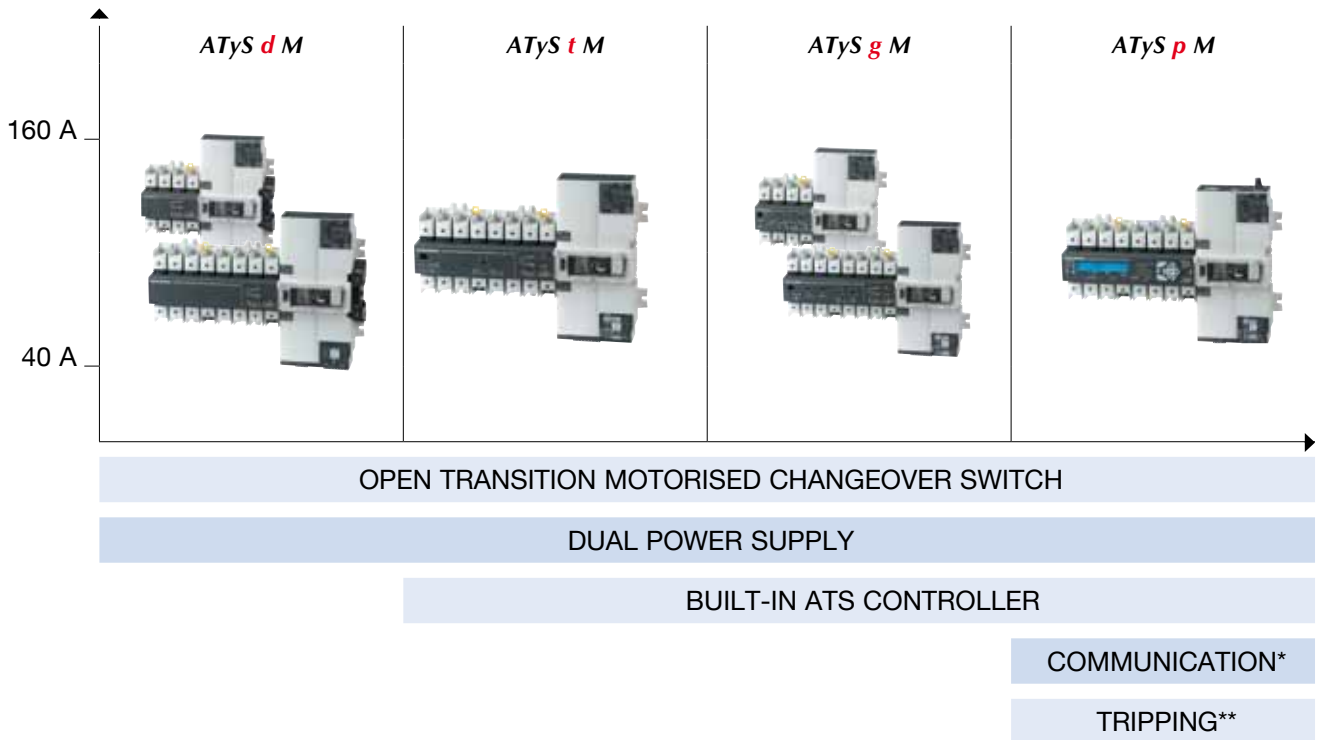

\* Specific version. \*\* Return to zero without external energy source.

### A product for virtually all power changeover applications from 40 to 160 A

- > Network/Genset
  - > Genset/Genset
  - > Network/Network
- Applications with an External ATS Control

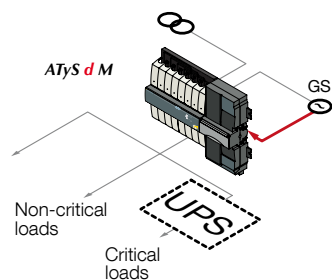

- > Network/Network
- Building applications

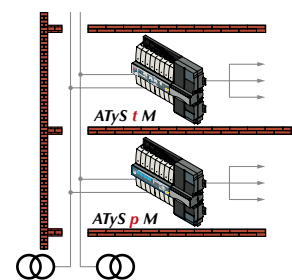

- > Network/Genset
- Genset Applications for Standby Power

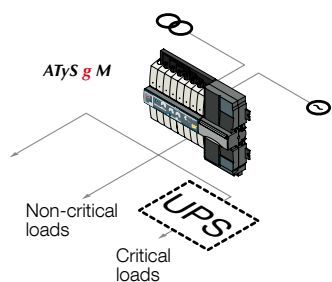

- > Network/Genset
- > Network/Network

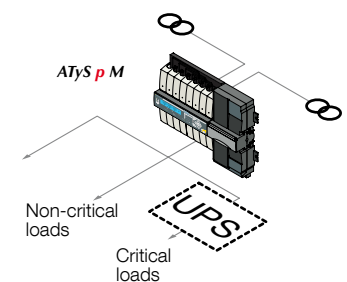



## 2.2.1. Selection guide

Six ratings 40/63/80/100/125/160 A

	ATyS <i>d</i> M	ATyS <i>t</i> M	ATyS <i>g</i> M	ATyS <i>p</i> M
<b>APPLICATIONS</b>				
Normal/Backup without automatic controller	•			
Normal/Backup with built-in automatic controller		•	•	•
Stable positions	•	•	•	•
Load changeover	•			
<b>FUNCTIONS</b>				
<b>POWER SUPPLY</b>				
External	•			
Integrated		•	•	•
<b>OPERATION</b>				
Backup manual operation of the 3 positions	•	•	•	•
Electrical (dry contact) control of positions I, 0 and II	•			•*
Automatic control of positions I, 0 and II		•	•	•
Return to 0 position feature upon loss of source				•
<b>MONITORING</b>				
3 voltages on networks I and II		•	•	•
Frequency on networks I and II		•	•	•
Phase rotation on networks I and II				•
Asymmetry of networks I and II				•
<b>AUTOMATIC CONTROLLER CONFIGURATION</b>				
By potentiometer and micro-switch		•	•	
By screen + keyboard				•
V <sub>n</sub> , F <sub>n</sub> , V threshold, F threshold		•	•	•
Driving with or without priority		•	•	•
Adjustable operating timers		•	•	•
Control type (impulse or switch/contactor)	•			
<b>DISPLAY</b>				
Position, fully visualised breaking	•	•	•	•
LED: source status, automatic mode, fault LED		•	•	•
LED: switch positions, supply, tests, control				•
V, F, timers, number of operations, last event				•
<b>REMOTE CONTROL</b>				
<b>Outputs</b>				
Generator start/stop order			•	•
Product availability (not fault and not manual mode)			•	•*
Source available		•		•*
Programmable output (source, availability, fault)				•*
<b>Inputs</b>				
Test on load			•	•*
Retransfer			•	•*
Automatic mode inhibit		•	•	•*
Position 0 order		•		•*
Priority		•	•	•
Other programmable inputs (test off-load, position control, etc.)				•*
<b>Remote control</b>				
Human/Machine Interface (D10 and D20)				•
RS485 communication (MODBUS)				•**

\* 3 inputs/3 outputs (programmable).

\*\* Product reference is different: communication by RS485 connection (MODBUS) allows up to 31 ATyS M to be connected to a PC or a PLC over 1500 m.

# 3. QUICK START

## 3.1. Quick Start ATyS p M



QUICK START EN 40 - 160A (4P)

# ATyS p M

Automatic  
Transfer Switching Equipment

### Preliminary operations

Check the following upon delivery and after removal of the packaging:

- Packaging and contents are in good condition.
- The product reference corresponds to the order.
- Contents should include:  
Qty 1 x ATyS M  
Qty 1 x Emergency handle extension rod  
Qty 1 x Set of terminals  
Quick Start instruction sheet

### Warning

**⚠ Risk of electrocution, burns or injury to persons and / or damage to equipment.**

This Quick Start is intended for personnel trained in the installation and commissioning of this product. For further details refer to the product instruction manual available on the SOCOMECE website.

- This product must always be installed and commissioned by qualified and approved personnel.
- Maintenance and servicing operations should be performed by trained and authorised personnel.
- Do not handle any control or power cables connected to the product when voltage may be, or may become present on the product, directly through the mains or indirectly through external circuits.
- Always use an appropriate voltage detection device to confirm the absence of voltage.
- Ensure that no metal objects are allowed to fall in the cabinet (risk of electrical arcing).

Failure to observe good engineering practises as well as to follow these safety instructions may expose the user and others to serious injury or death.

**⚠ Risk of damaging the device**

- In case the product is dropped or damaged in any way it is recommended to replace the complete product.

### Accessories

- Bridging bars 125A or 160A.
- Control voltage transformer (400Vac -> 230Vac).
- Voltage sensing and power supply tap.
- Terminal shrouds.
- Auxiliary contact blocks.
- Polycarbonate enclosure.
- Polycarbonate extension box.
- Power Connection Terminals.
- ATyS D10 remote display unit.
- ATyS D20 remote control and display unit.



www.socomec.com  
www.socomec.com/en/atys-p-m  
To download, brochures, catalogues and technical manuals.

Printing informations: 1 color Black. White paper 90g/m<sup>2</sup>.  
Printing size: 420x297. Final size 210x297. This page visible first.  
A separate sheet for each language.

CORPORATE HQ CONTACT:  
SOCOMECE SAS, 1-4 RUE DE WESTHOUSE, 67235 BENFELD, FRANCE



542 934 C - 12/16 - EN Non contractual document. Subject to change without notice.

### Installation and Commissioning

**STEP 1**  
Cabinet / Back Plate Installation

**STEP 2**  
Connecting the POWER section

**STEP 3**  
CONTROL / AUX POWER terminal connections

**STEP 4**  
CHECK

**STEP 5**  
PROGRAMMING

**STEP 6A**  
Automatic Operation

**STEP 6B**  
Emergency Manual Operation

**STEP 6C**  
Padlocking

**Power Supply LED**  
1 green LED  
- Always off: both power supplies off or software error if other indicators are on.  
- Always on: product power supply on.

**Fault LED**  
1 red LED to indicate the status of the product. Open and close the AUT/MAN cover to reset the fault.

**Capacitor charging**  
Return to zero capacitor charge. While the indicator is flashing, the return to 0 function is unavailable.

**Operating mode**  
☰: 1 yellow LED for MANU mode active. AUT: 1 green LED for AUTO mode active.

### STEP 3

#### CONTROL / AUX POWER Terminals and wiring

Type	Terminal no.	Description	Characteristics	Recommended connection cross-section
Inputs	207	Common point for inputs	Do not connect to any power supply Supply from the product	0.5 to 2.5 mm <sup>2</sup> (rigid)
	208	I1: programmable input		
	209	I2: programmable input		
	210	I3: programmable input		
Outputs	43/44	O1: programmable output	Resistive load 2A 30Vdc 0.5A 230Vac Pmax: 60W or 115VA Umax: 30Vdc or 230Vac	0.5 to 1.5 mm <sup>2</sup> (stranded)
	53/54	O2: programmable output		
	63/64	O3: programmable output		
	73/74	G: generator stat signal		
Remote interface connection	RJ	ATyS D10/D20 human/machine interface	Maximum distance 3 m	RJ45 8/8 straight cable Cat. 5
Serial connection (specific version)	RS485	Connection RS485 0: interconnection of cable shielding upstream and downstream of RS485 bus -: negative terminal of RS485 bus +: positive terminal of RS485 bus	RS485 bus insulated	LiVCY shielded twisted pair, 0.5 to 2.5 mm <sup>2</sup>

Type	Terminal no.	Status of the contact	Description	Output characteristics	Recommended connection cross-section
Auxiliary contact block 1309 0001	11/12/14	11 —14 12	Changeover switch in position I	250V AC 5A AC1 - 30 Vdc 5A	0.5 to 2.5 mm <sup>2</sup> (rigid)
		21 —24 22	Changeover switch in position II		
	01/02/04	01 —04 02	Changeover switch in position 0		
Auxiliary contact block 1309 0011	11/12/14	11 —14 12	Changeover switch in position I		
		21 —24 22	Changeover switch in position II		
	01/02/04	01 —04 02	Changeover switch in position 0		

## STEP 1

### Installation

Caution: Ensure that the product is installed on a flat rigid surface.

#### Recommended orientation

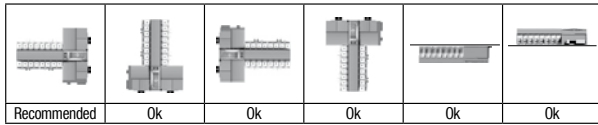

DIN RAIL  
IEC 60715

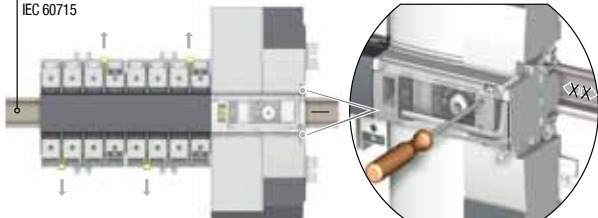

Tighten to avoid movement on the DIN rail.

Posidriv PZ1  
1 Nm

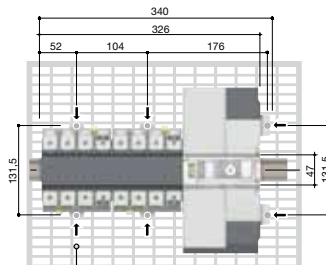
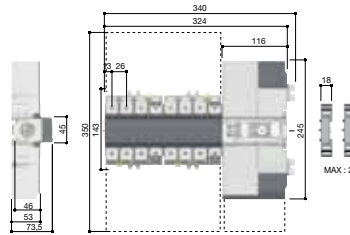

6 mounting brackets  
6x M6 screw - 2,5 Nm

### Padlocking configuration

The ATyS M is delivered with padlocking configured to the 0 position.

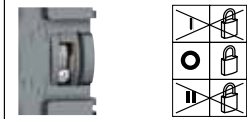

To allow padlocking in all positions (I - 0 - II), configure the ATyS M as follows before installation. (Screw is located at the back of the product).

## STEP 2

### Power Terminal Connections

It is essential to tighten all used terminals, with cables and/or bridging bars, before use.



Source supply side

Load side  
bridging bar.  
125A: 1309 4006  
160A: 1309 4016

Hexagonal Metric  
Allen size 4  
5,0 Nm

10 to  
70 mm<sup>2</sup>  
[15mm]

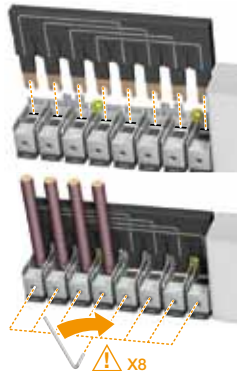

Voltage taps provide 2x  $\leq 1.5\text{mm}^2$  connections. They can be fitted in any terminals on the source supply side. Do not use on the load side when equipped with a bridging bar.

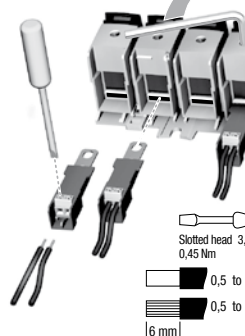

Slotted head 3,5 mm  
0,45 Nm

0,5 to 2,5 mm<sup>2</sup>  
0,5 to 1,5 mm<sup>2</sup>  
[6 mm]

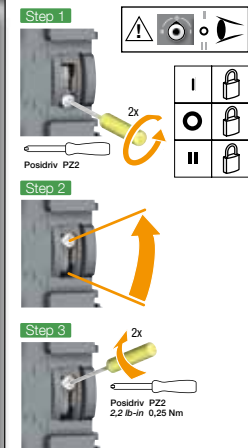

0,5 to 2,5 mm<sup>2</sup>  
0,5 to 1,5 mm<sup>2</sup>  
[6 mm]

Slotted head 3mm 0,5 Nm

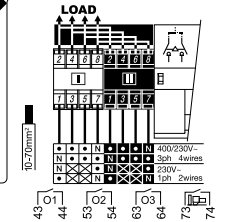

See instruction sheet

Ensure that the product is in Manual Mode (front cover open).

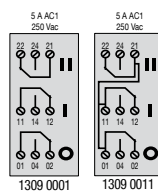
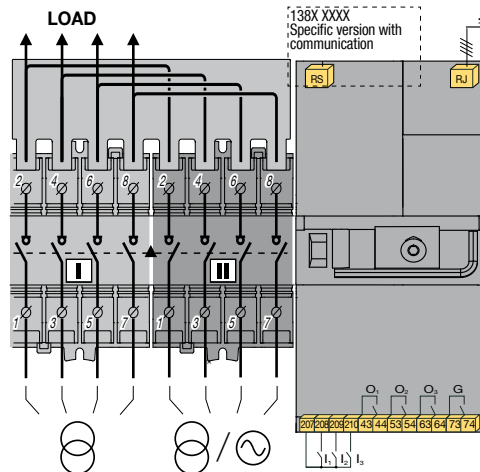

Slotted head 3,5 mm  
0,45 Nm

0,5 to 2,5 mm<sup>2</sup>  
0,5 to 1,5 mm<sup>2</sup>  
[6 mm]

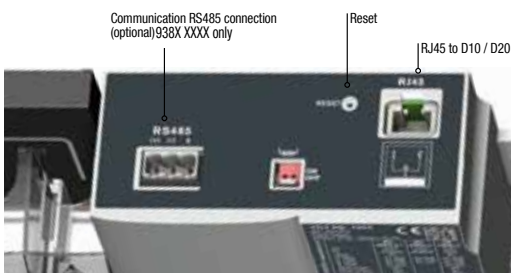

Communication RS485 connection  
(optional) 938X XXXX only

Reset

RJ45 to D10 / D20

### Auxiliary contacts: Fitting of auxiliary contacts: 1309 0001 or 1309 0011

To fit an AC, the switch must first be put in position 0. An auxiliary contact module comprises: one NO/NC changeover contact for each position (I-0-II). To install use the long screws supplied with the module.

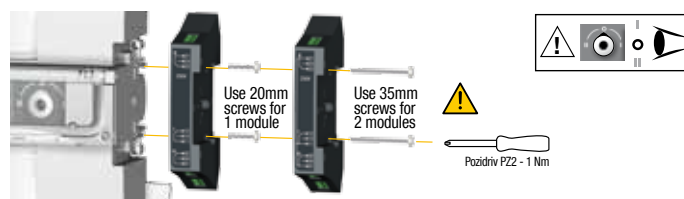

Use 20mm screws for 1 module

Use 35mm screws for 2 modules

Posidriv PZ2 - 1 Nm

## STEP 4

Check



Whilst in manual mode, check the wiring and if ok power up the product.



## STEP 5

Programming

Product programming

Programming access is possible in Automatic mode, when the product is in position I with source 1 available, and in Manual mode in any position and with at least one available source.

**Note:** For complete programming details: download the instruction manual from the Socomec website.

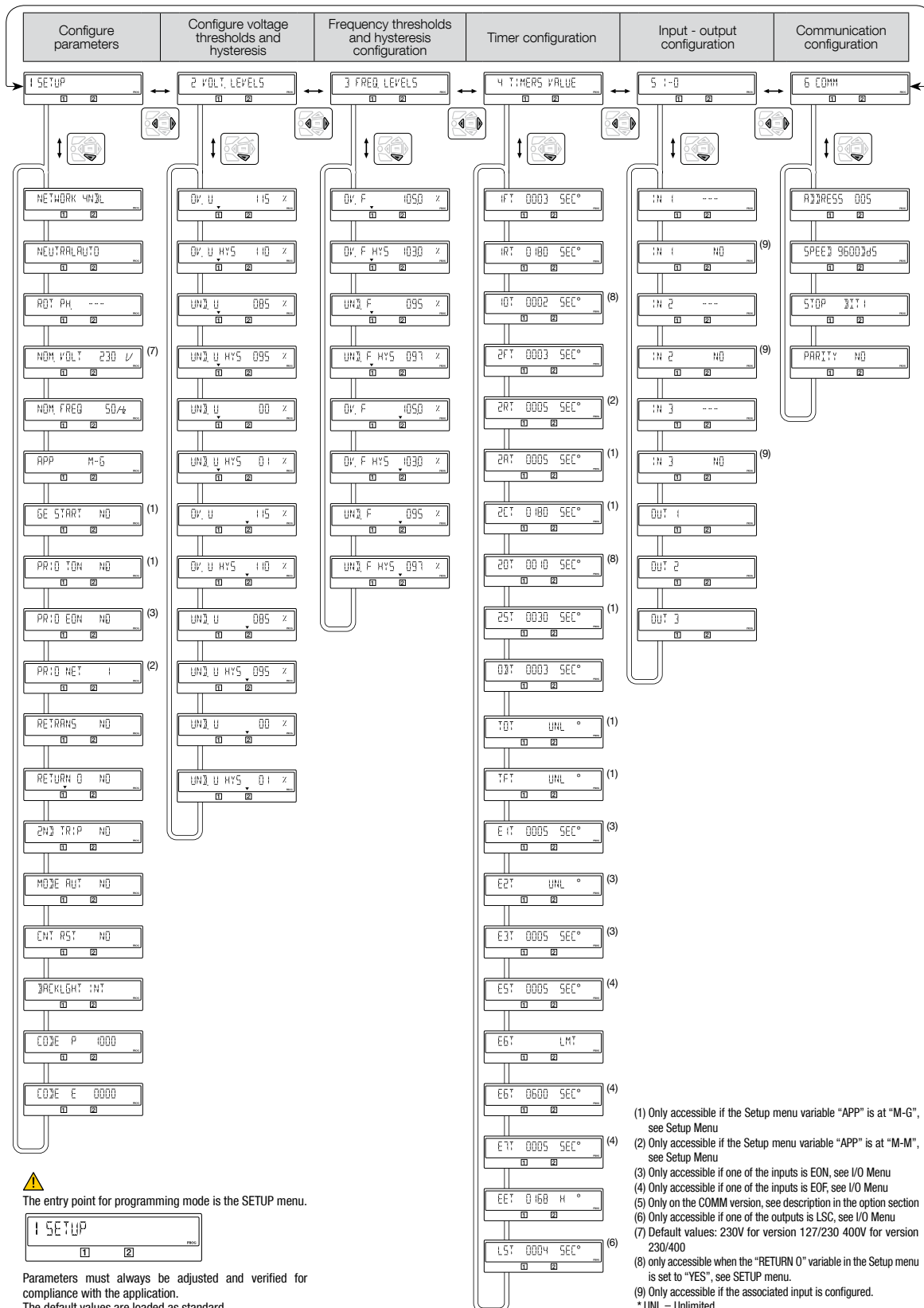

**To access programming**  
Default code: 1000

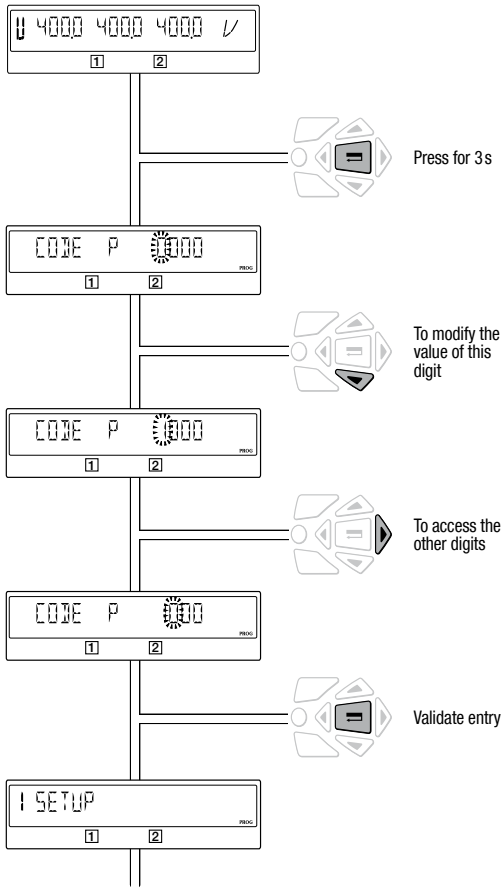

**Browsing**

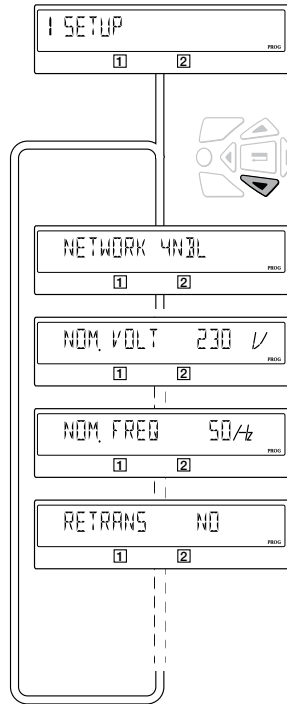

**Exit programming**



**STEP 6A**

**Automatic operation**

Close the front cover as shown to put the product into automatic mode.



**STEP 6B**

**Manual operation**

- Open the front cover as shown to put into manual mode.
- Use the handle situated in the front panel under the cover to operate the transfer switch.
- Check the changeover switch position on the indicator before operating.

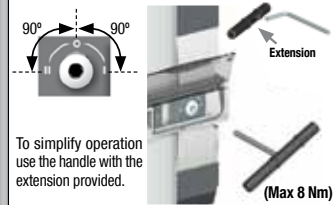

**STEP 6C**

**Padlocking mode**

- In order to padlock put the product in manual mode.
- Pull the locking mechanism and insert a padlock as shown.
- As standard padlocking in the 0 position. Configurable to I-0-II (see step 1).

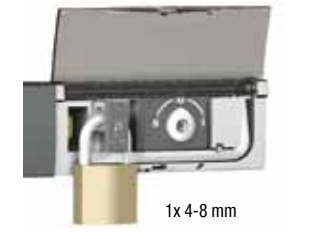

TIMERS		Setting range	Default Value
1FT	Loss of source 1 Validation timer.	0 to 60 sec	3 sec
1RT	Source 1 return validation timer.	0 to 3600 sec	180 sec
2FT	Loss of source 2 Validation timer.	0 to 60 sec	3 sec
2RT	Source 2 return validation timer.	0 to 3600 sec	5 sec
2AT	Standby network stability validation before transfer	0 to 3600 sec	5 sec
2CT	Run on timer.	0 to 600 sec	180 sec
ODT	Dead band timer.	0 to 20 sec	3 sec
Parameters		Setting range	Default value
NEUTRAL	Neutral position on the switch AUTO: neutral position is automatically detected when the product is supplied the first time. LEFT: neutral must be connected to the left that means on the terminal 1 from each switch. RIGHT: neutral must be connected to the right that means on the terminal 7 from each switch.	AUTO LEFT RIGHT	AUTO
NOM. VOLT.	Nominal voltage Phase/phase or phase/neutral in 1BL and 41NBL	From 180 to 480 Vac	400Vac (230/400V version) 230Vac (127/230V version)
NOM. FREQ.	Nominal Frequency	50 or 60Hz	50Hz
APP	Type of application M-G: network - Genset M-M: network - network	M-G M-M	M-G
RETRANS	Retransfer inhibit feature, press on Validation button required to allow retransfer form Gen to Main	YES or NO	NO
NETWORK	Network configuration*	3NBL / 4NBL / 41NBL / 1BL (230/400V version) 4NBL / 3NBL / 2NBL / 42NBL (127/230V version)	4NBL

\* The wiring must be adapted to the network configuration. Below, the main configuration types.

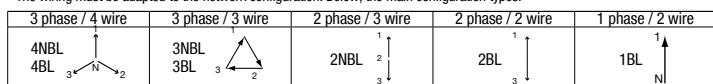

## 4. ATyS P M VERSIONS

The ATyS p M is available as a 4P product with integrated 230/400Vac control voltage taken directly off the power section.

On option it is available with RS485 communication.(Modbus Slave).

### 4.1. Product presentation

This quick-acting source transfer switch incorporates:

1. 2 mechanically interlocked switches including an electronic control-command module.
2. A quick-acting electric control unit enabling automatic or manual system operation.
3. Electrical specifications compliant with product standards, and a version identification.
4. Changeover switch wiring identification.
5. Control connections.
6. An RJ45 connection for a remote interface D10 / D20.
7. A connector for RS485 communication (Modbus), for the version with communication.



### 4.2. Specifications and advantages

- 1 - Power section:  
A fully integrated and interlocked transfer switch, with high electrical performance offering microprocessor control and monitoring.
- 2 - Operation:  
A flexible operating mechanism enabling quick motorised transfer in automatic mode or locally in manual mode for emergency operations. Features a locking device to ensure (in position zero) a secured isolation of the load (padlocked).











### 4.3. Supply types

The power supply of ATyS p M is required to be 230VAC  $\pm$  30% at a frequency of 50/60 Hz and has been developed so as to meet most network configurations.

Product's working ranges:

	Version 230 / 400 VAC		Version 127 / 230 VAC	
	Umin	Umax	Umin	Umax
Ph-N	160	305	160	305
Ph-Ph	277	528	160	305

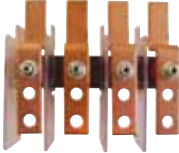
## 5. OPTIONAL ACCESSORIES

<p>Auxiliary contacts</p>	<p>Each product can take up to 2 auxiliary contact blocks. Each accessory integrates 1 NO/NC auxiliary contact (for each position I, O and II) 1309 0001 or NO/NC for 1309 0011.</p> <p>Characteristics: 250 VAC / 5 A maximum.</p>		<p>Ref. : 1309 0001 Ref. : 1309 0011</p>
<p>Bridging bars</p>	<p>To provide a common point on the outgoing side of the switch (load side).</p>		<p>2 Refs are available: Rating <math>\leq 125A</math>: 1309 4006 and rating 160A: 1309 4016</p>
<p>Remote control interfaces D10/D20</p>	<ul style="list-style-type: none"> <li>- Use. Adapted to applications requiring the changeover switch to be fitted inside the cabinet. Product self-supplied via the RJ45 connection lead with ATyS M. Maximum connection distance: 3 m.</li> <li>- D10. For transferring source and changeover switch statuses to the cabinet front panel. IP rating: IP21.</li> <li>- D20. In addition to the D10 interface functions, enables configuration, checking, tests and measurements display. IP rating: IP21.</li> <li>- Door mounted. 2 holes, <math>\varnothing 22.5</math>. Connection to ATyS M via the Socomec 1599 2009 connection cable.</li> </ul>		<p>Ref. D10: 1599 2010 Ref. D20: 1599 2020</p>
<p>Connecting cable for remote interfaces</p>	<p>For connecting between a remote interface and a checking product.</p> <p>RJ45 3 m straight uninsulated cable.</p>		<p>Ref. : 1599 2009</p>
<p>Voltage sensing and power supply tap</p>	<p>It allows connection of 2 x 1.5 mm<sup>2</sup> voltage sensing or power cables. The single-pole voltage sensing tap can be mounted in the terminals without reducing their connecting capacity. Do not use with the bridging bar.</p>		<p>Ref. : 1399 4006 2 parts/ref.</p>
<p>Terminal shrouds</p>	<p>Protection against direct contacts with terminals or connecting parts. Other features: Perforations allowing remote thermographic inspection without removal. Possibility of sealing.</p>		<p>Ref. : 2294 4016 2 parts/ref.</p>
<p>Enclosure</p>	<p>Fully dedicated to ATyS M use, this polycarbonate enclosure provides easy access to a compact, enclosed transfer switch.</p>		<p>Ref. : 1309 9006</p>
<p>Extension unit</p>	<p>Combined with the polycarbonate enclosure, the extension box creates extra space for routing cables with a larger diameter.</p>		<p>Ref. : 1309 9007</p>
<p>Power connection terminals</p>	<p>The power connection terminals allow conversion of the cage terminals into bolt-on type connection terminals, enabling connection of up to two 35mm<sup>2</sup> cables or one 70mm<sup>2</sup> cable. Each power connection terminal is provided with separation screens.</p>		<p>Ref. : 1399 4017 For complete conversion, order 3 times the reference.</p>
<p>Auto-transformer</p>	<p>For use with ATyS M in 400 VAC three-phase applications without a distributed neutral. As the ATyS M has integrated measurement and power supply circuits, a neutral connection is required for 400 VAC three-phase applications. When no neutral connection is available this autotransformer (400/230 VAC, 400 VA) provides the 230 VAC required for the ATyS M to function.</p>		<p>Ref. : 1599 4121</p>

## 6. TECHNICAL DATA

Ratings		40A	63 A	80 A	100 A	125 A	160 A
Frequencies		50/60 Hz	50/60 Hz	50/60 Hz	50/60 Hz	50/60 Hz	50/60 Hz
Thermal current I <sub>th</sub> at 40 °C (A)		40	63	80	100	125	160
Thermal current I <sub>th</sub> at 50 °C (A)		40	63	80	100	110*	125
Thermal current I <sub>th</sub> at 60 °C (A)		40	50	63	80	100*	125
Thermal current I <sub>th</sub> at 70 °C (A)		40	40	50	63	80*	100
Rated assigned insulation voltage U <sub>i</sub> (V) (Power circuit)		800	800	800	800	800	800
Rated impulse withstand voltage U <sub>imp</sub> (kV) (power circuit)		6	6	6	6	6	6
Rated insulation voltage U <sub>i</sub> (V) (control circuit)		300	300	300	300	300	300
Rated impulse withstand voltage U <sub>imp</sub> (kV) (control circuit)		2.5	2.5	2.5	2.5	2.5	2.5
Rated operational currents (A) IEC 60947-3 at 415VAC at 40 °C	AC 21A / 21 B	40/40	63/63	80/80	100/100	125/125	160/160
	AC 22A / 22 B	40/40	63/63	80/80	100/100	125/125	125/160
	AC 23A / 23 B	40/40	63/63	80/80	100/100	125/125	125/160
Rated operational currents (A) IEC 60947-6-1 415Vac at 40 °C	AC 33B / AC32B **AC 33iB	40/40	63/63	80/80	100/100	125/125	125**/160
Fuse protected short-circuit withstand if using gG DIN fuses	Fuse protected short-circuit withstand (kA eff)	50	50	50	50	50	40
	Associated fuses (gG DIN)	40	63	80	100	125	160
Short-circuit capacity	Rated short-term withstand current: I <sub>cw</sub> 1s (kA eff)	4	4	4	4	4	4
	Rated short-term withstand current: I <sub>cw</sub> 30ms (kA eff)	10	10	10	10	10	10
Switching time at I <sub>n</sub> excluding loss of supply sensing time and excluding any delay timers applicable.	I-II or II-I (ms)	180	180	180	180	180	180
	Duration of "electrical blackout" at U <sub>n</sub> (ms)	90	90	90	90	90	90
	I-O / O-I / II-O / O-II (ms)	45	45	45	45	45	45
Consumption	Inrush current(A)	20	20	20	20	20	20
	Consumption in stabilised state (VA)	6	6	6	6	6	6
Mechanical characteristics	Number of changeovers	10000	10000	10000	10000	10000	10000
Connection cross-section (⚠ not compatible with aluminium cables)	Minimum size (Cu mm <sup>2</sup> ), flexible and rigid	10	10	10	10	10	10
	Maximum size (Cu mm <sup>2</sup> ), flexible and rigid	70	70	70	70	70	70
Equipment class (According to IEC 60947-6-1)		PC	PC	PC	PC	PC	PC
EMC environment		A	A	A	A	A	A

\* Possibility of reaching 125A with bigger connection cross-sections and use of the 160A bridging bar.

\*\* AC 33iB 160A according to GB 14048.11.



This is a class A product. In a domestic environment, this product may cause radio interference in which case the user may be required to take adequate measures.



# 7. ENVIRONMENTAL CONDITIONS



## Humidity

- 80 % humidity without condensation at 55 °C
- 95 % humidity without condensation at 40 °C



## Temperature

- -20 +40 °C without de-rating
- 40 °C < t ≤ 70 °C with de-rating (see Technical Characteristics)



## Altitude

- Max 2000 m without de-rating

Correction factors:

	2 000 m < A ≤ 3 000 m	3 000 m < A ≤ 4 000 m
UE	0.95	0.80
le	0.85	0.85



## Storage

- 1 year maximum
- Maximum storage temperature: +55 °C
- 80 % humidity without condensation at 55 °C



## IP rating

- IP41 in the SOCOMEC polycarbonate modular enclosure see «10.1. Polycarbonate enclosure», page 22
- IP2x for non-enclosed modular product

Protection class: Class 1

# 8. PRODUCT INSTALLATION



Prior to installation of the product ensure that the padlocking setting screw (located at the back of the product) is configured as per your requirements.  
For locking in Positions I, II and 0, refer to the following procedure

## 8.1. Changing the padlocking configuration

To configure the locking in the 3 positions:

STEP1: loosen the screw at the back of the product as shown below.

STEP2: slide the screw upwards.

STEP3: tighten the screw in the top position as shown.

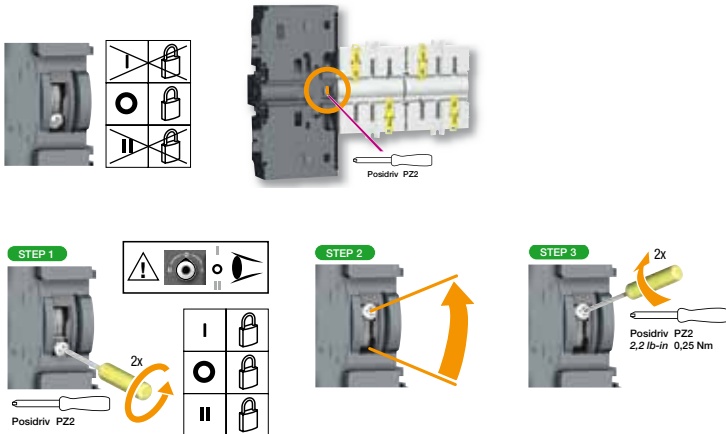

## 8.2. Recommended orientation

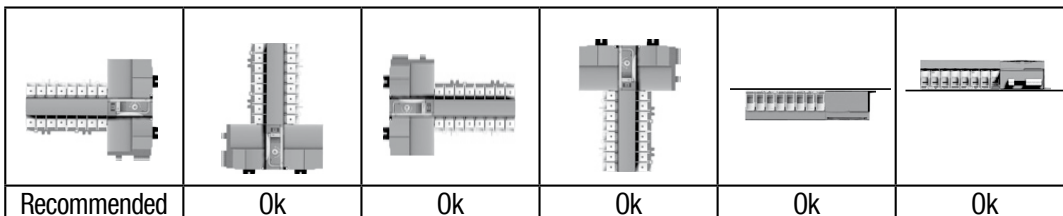

## 8.3. Dimensions

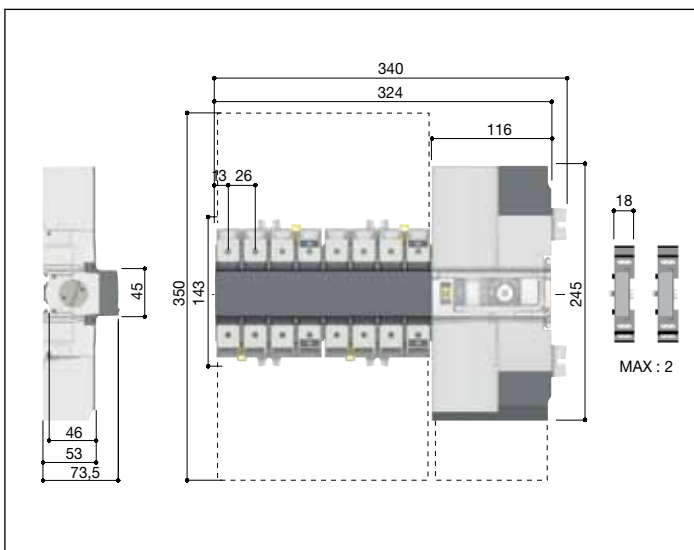

## 8.4. Back plate mounted

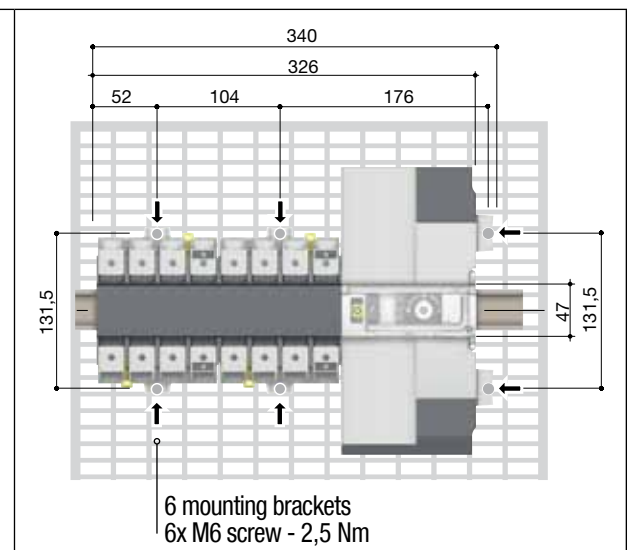

## 8.5. DIN rail mounted

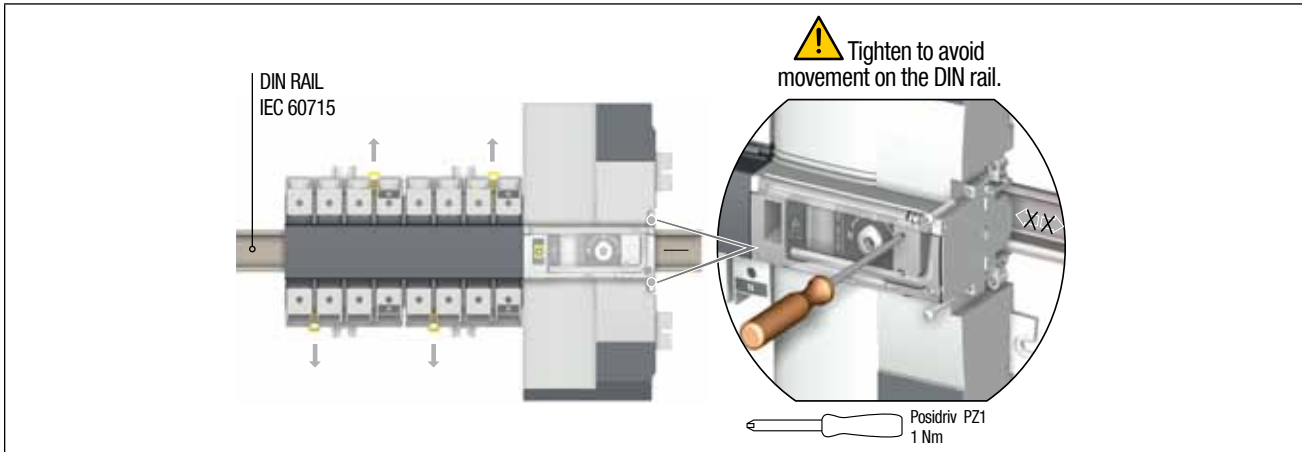

# 9. INSTALLATION OF OPTIONAL ACCESSORIES

## 9.1. Auxilliary contacts

Ref. 1309 0001 or ref. 1309 0011.

To fit an AC, the switch must first be put in the 0 position. An auxiliary contact module comprises: one NO/NC changeover contact for each position (I-0-II). To install use the screws supplied with the module.

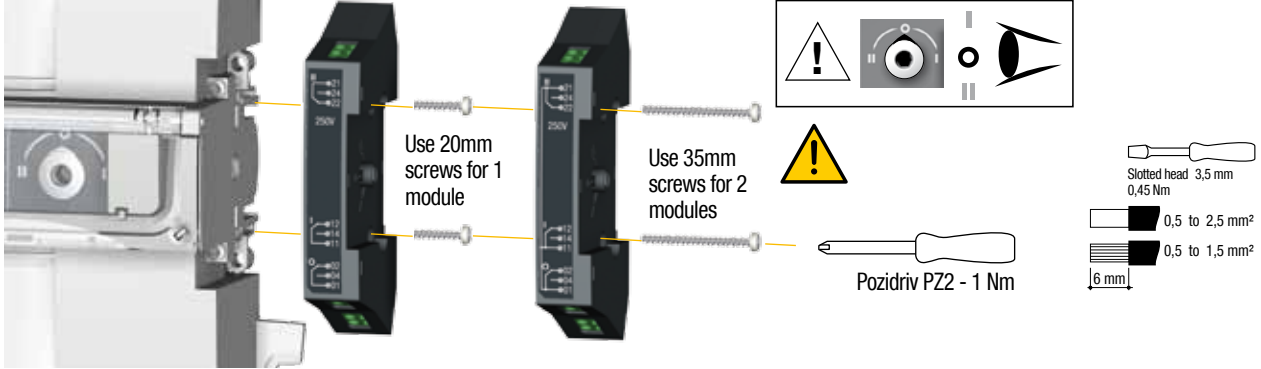

## 9.2. Voltage sensing and power supply tap

Ref. 1399 4006.

This provides 2 connection terminals for conductors with cross-section  $\leq 1.5 \text{ mm}^2$ .

The single pole terminals can be fitted in any of the terminal cages without reducing the cage connection capacity. 2 parts/ref. Do not use in case of use of the bridging bar.

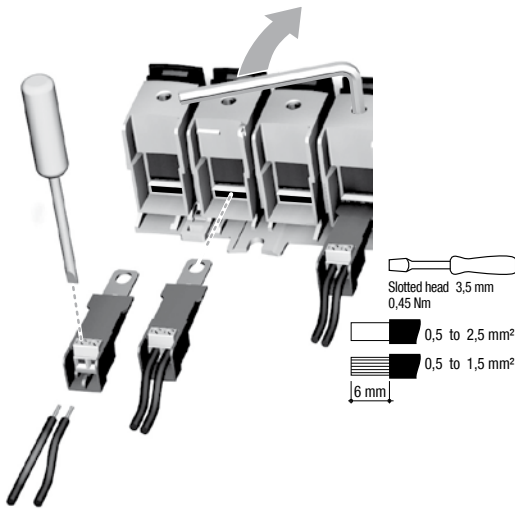

## 9.3. Bridging bars 4P

Ratings  $\leq 125\text{A}$ : ref. 1309 4006; 160A: ref. 1309 4016

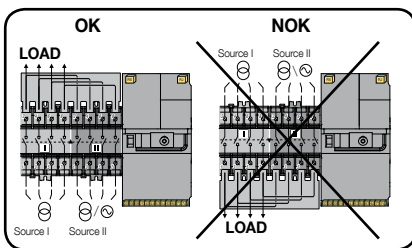

Load side bridging bar.  
125A: 1309 4006  
160A: 1309 4016

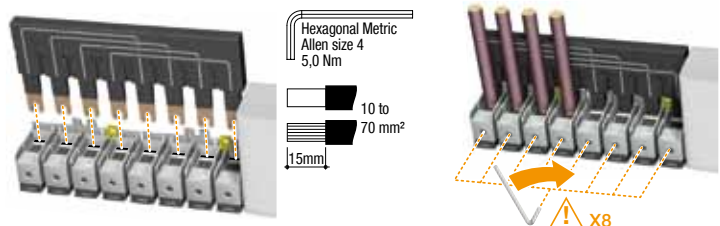

Make sure that the bridging bar is fitted to the correct set of terminals. There are two references available: one for ratings up to 125A, and another for 160A rating.

## 9.4. Terminal shrouds

Ref. 2294 4016

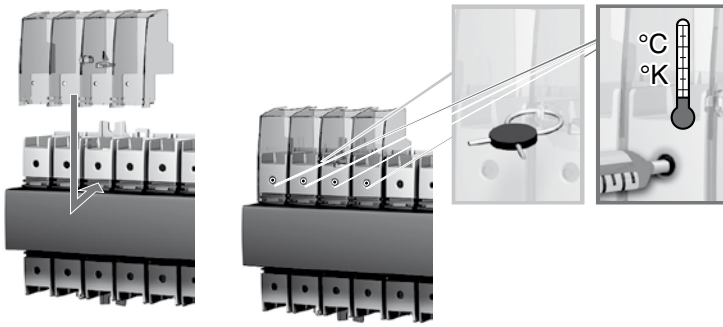

# 10. INSTALLING WITHIN THE ATYS M ENCLOSURE

## 10.1. Polycarbonate enclosure

Ref. 1309 9006

Dimensions and mounting

The enclosure must be wall-mounted using screws (not supplied). Recommended size: M6 50 mm (minimum).  
Weight: between 8 and 10 kg, depending on the accessories.



Only 1 aux contact block may be installed when using this enclosure.

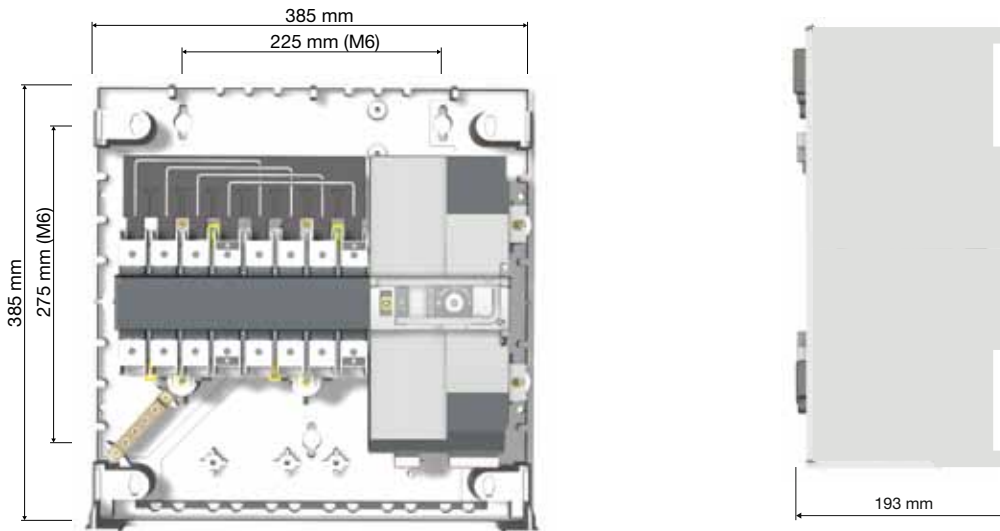

### 10.1.1. Wiring in a polycarbonate enclosure

Example: Neutral on the right



Max cable size 25 mm<sup>2</sup>

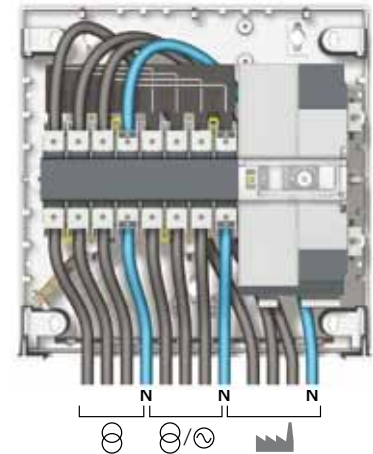

### 10.1.2. Extension unit

Ref. 1309 9007



Enables you to allocate additional space to the polycarbonate enclosure (ref. 1309 9006).

# 11. CONNECTION OF THE POWER CIRCUITS

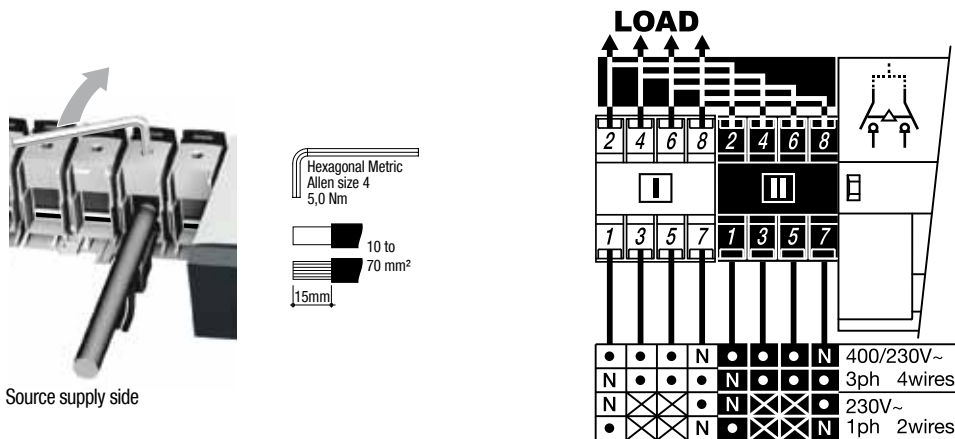

Source supply side



It is essential to tighten all used terminals, with cables and/or bridging bars, before use.

## 11.1. Ratings / cross-sections table of correspondence

	40 A	63 A	80 A	100 A	125 A	160 A
Min cable size recommended (mm <sup>2</sup> )	10	16	25	35	50	50
**Max cable size recommended (mm <sup>2</sup> )	50	50	50	50	70*	70*

\*With extension unit.

\*\* Maximum cable size for rigid cable is 50 mm<sup>2</sup>. For larger terminations use the power connection terminals ref. 1399 4017.



Not compatible with aluminium cables

## 11.2. Parallel pole set-up for a 4P device used in single phase

Rating conversion table for use in single phase and two-by-two parallel pole set up.  
(Max ambient temperature = 40 °C).

Nominal current rating in three-phase (A)	Nominal current rating in single-phase (2 poles in //) (A)
40	63
63	100
80	125
100	160
125	200
160	250

# 11.3. Network configurations

## 11.3.1. Voltage configurations for 230/400VAC versions

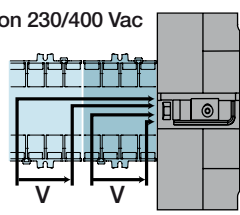
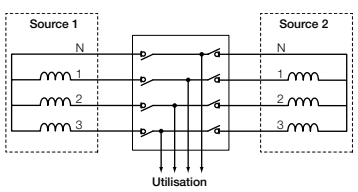
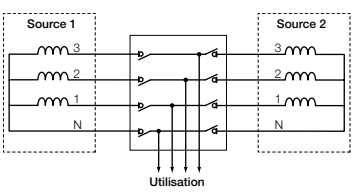
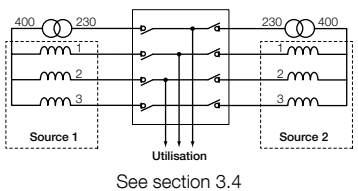
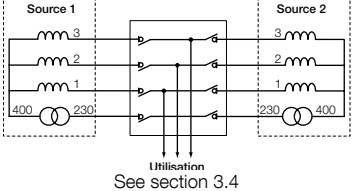
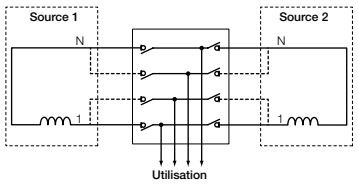
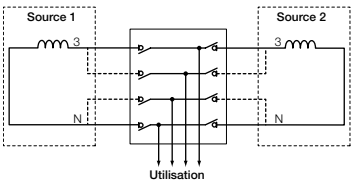
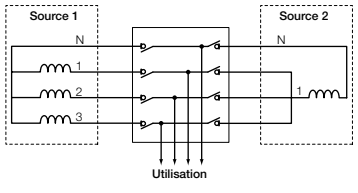
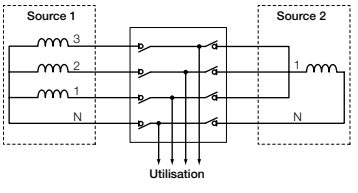
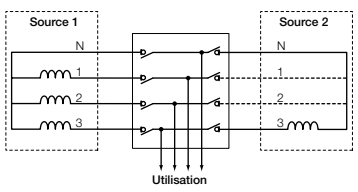
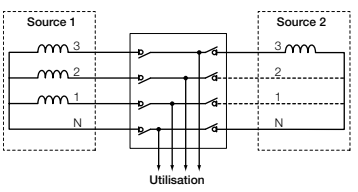
Type		Wiring													
<p>Version 230/400 Vac</p>  <p>V = 160-305 Vac 45-65 Hz</p>		Name		Neutral Position (1)		Source I			Source II						
Neutral on the left		Neutral on the right													
				4NBL		Left		N	L1	L2	L3	N	L1	L2	L3
						Right		L3	L2	L1	N	L3	L2	L1	N
 <p>See section 3.4</p>		 <p>See section 3.4</p>		3NBL		Left			L1	L2	L3		L1	L2	L3
						Right		L3	L2	L1		L3	L2	L1	
				1BL		Left		N	(N)	(L1)	L1	N	(N)	(L1)	L1
						Right		L1	(L1)	(N)	N	L1	(L1)	(N)	N
				41 NBL		Left		N	L1	L2	L3	N	L1	L1	L1
						Right		L3	L2	L1	N	L1	L1	L1	N
				42 NBL		Left		N	L1	L2	L3	N	(L1)	(L2)	L3
						Right		L3	L2	L1	N	L3	(L2)	(L1)	N

--- : optional wiring



Neutral must be wired on the left or the right.

(1) Neutral position on the product

The neutral position should be configured in the setup menu:

- auto : the neutral position is defined automatically each time the cables are connected
- Neutral on the left: neutral forced left
- Neutral on right : neutral forced right



Detections							Monitoring/Display <sup>(4)</sup>				Vectors
Neutral <sup>(2)</sup>			Rotation <sup>(3)</sup>		Balancing		Source I		Source II		
Srce I	Srce II	Srce I ≠ Srce II	Srce I	Srce II	Srce I	Srce II	Ph-Ph	Ph-N	Ph-Ph	Ph-N	
Left	Left	Yes	ABC ACB	ABC ACB	Yes	Yes	3 U	3 V	3 U	3 V	
Right	Right	Yes	ABC ACB	ABC ACB	Yes	Yes					
Left	Left	Yes	ABC ACB	ABC ACB	Yes	Yes	3 U	0 V	3 U	0 V	
Right	Right	Yes	ABC ACB	ABC ACB	Yes	Yes					
EITHER	EITHER	No	EITHER	EITHER	No	No	0 U	1 V	0 U	1 V	
EITHER	EITHER	No	EITHER	EITHER	No	No					
Left	Left	Yes	ABC ACB	EITHER	Yes	No	3 U	3 V	0 U	1 V	
Right	Right	Yes	ABC ACB	EITHER	Yes	No					
Left	Left	Yes	ABC ACB	EITHER	Yes	No	3 U	3 V	1 U	0 V	
Right	Right	Yes	ABC ACB	EITHER	Yes	No					

(2) **yes:** the product recognises whether the network 1 neutral position is not the same as for network 2: an error message is then displayed FO3 - NEUTRAL  
**no:** the product does not recognise whether the network 1 neutral position is different from network 2: the measurements may be incorrect  
**EITHER:** position undetermined

(3) It is possible to configure the direction of phase rotation in the Setup menu: clockwise or anti-clockwise  
**EITHER:** the phase rotation is not controlled.

(4) : controlled voltage

### 11.3.2. Voltage configurations for 127/230VAC versions

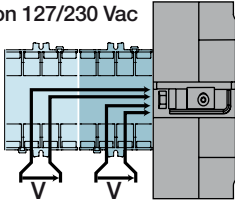
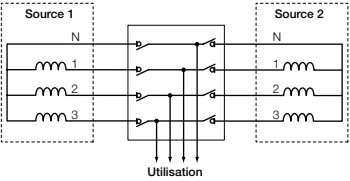
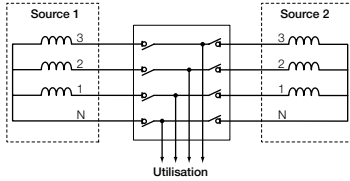
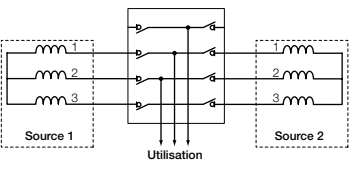
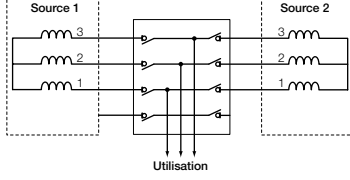
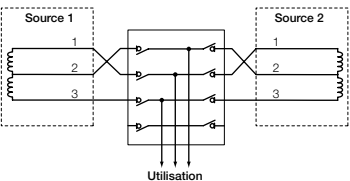
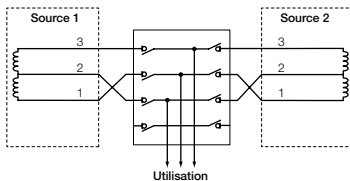
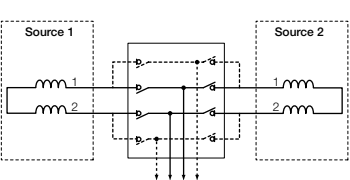
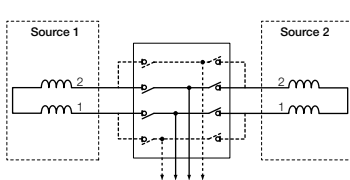
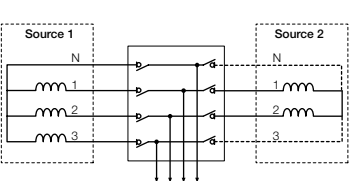
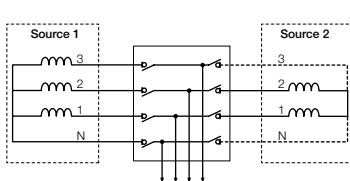
Type		Wiring											
 <p>Version 127/230 Vac</p> <p>V = 160-305 Vac 45-65 Hz</p>		Name		Neutral <sup>(1)</sup>				Source 1		Source 2			
		Neutral on the left				Neutral on the right							
		4 NBL		Left		N		L1		L2		L3	
				Right		L3		L2		L1		N	
		3 NBL		Left				L1		L2		L3	
				Right		L3		L2		L1			
		2NBL		Left		M		L1		L3			
				Right				L3		L1		M	
		2BL		Left		(L1)		L1		L2		(L2)	
				Right		(L2)		L2		L1		(L1)	
		42 NBL		Left		N		L1		L2		L3	
				Right		L3		L2		L1		N	

--- : optional wiring



Neutral must be wired on the left or the right.

(1) Neutral position on the product

The neutral position should be configured in the setup menu:

- auto : the neutral position is defined automatically each time the cables are connected
- Neutral on the left : neutral forced left
- Neutral on the right : neutral forced right

Detections							Monitoring/Display <sup>(4)</sup>				Vectors
Neutral <sup>(2)</sup>			Rotation <sup>(3)</sup>		Balancing		Source 1		Source 2		
Srce 1	Srce 2	Srce 1 ≠ Srce 2	Srce 1	Srce 2	Srce 1	Srce 2	Ph-Ph	Ph-N	Ph-Ph	Ph-N	
Left	Left	Yes	ABC ACB	ABC ACB	Yes	Yes	3 U	3 V	3 U	3 V	
Right	Right	Yes	ABC ACB	ABC ACB	Yes	Yes					
Left	Left	Yes	ABC ACB	ABC ACB	Yes	Yes	3 U	0 V	3 U	0 V	
Right	Right	Yes	ABC ACB	ABC ACB	Yes	Yes					
Left	Left	No	EITHER	EITHER	No	No	3 U	0 V	3 U	0 V	
Right	Right	No	EITHER	EITHER	No	No					
EITHER	EITHER	No	EITHER	EITHER	No	No	1 U	0 V	1 U	0 V	
EITHER	EITHER	No	EITHER	EITHER	No	No					
Left	Left	Yes	ABC ACB	EITHER	Yes	No	3 U	3 V	1 U	0 V	
Right	Right	Yes	ABC ACB	EITHER	Yes	No					

(2) **yes:** the product recognises whether the network 1 neutral position is not the same as for network 2: an error message is then displayed FO3 - NEUTRAL  
**no:** the product does not recognise whether the network 1 neutral position is different from network 2: the measurements may be incorrect  
**EITHER:** position undetermined

(3) It is possible to configure the direction of phase rotation in the Setup menu: clockwise or anti-clockwise  
**EITHER:** the phase rotation is not controlled.

(4) : controlled voltage

### 11.3.3. Three phase without neutral network

For three-phase networks without neutral (3NBL) 400Vac, a neutral must be recreated to allow the ATyS p M to operate at 230Vac. To recreate the neutral, we recommend the use of quantity 2x 400VA auto-transformers connected as shown below. The neutral position must be programmed in the SETUP Menu as neutral on the left or neutral on the right and wired accordingly.

The example below shows the wiring for a product configured with neutral on the left.

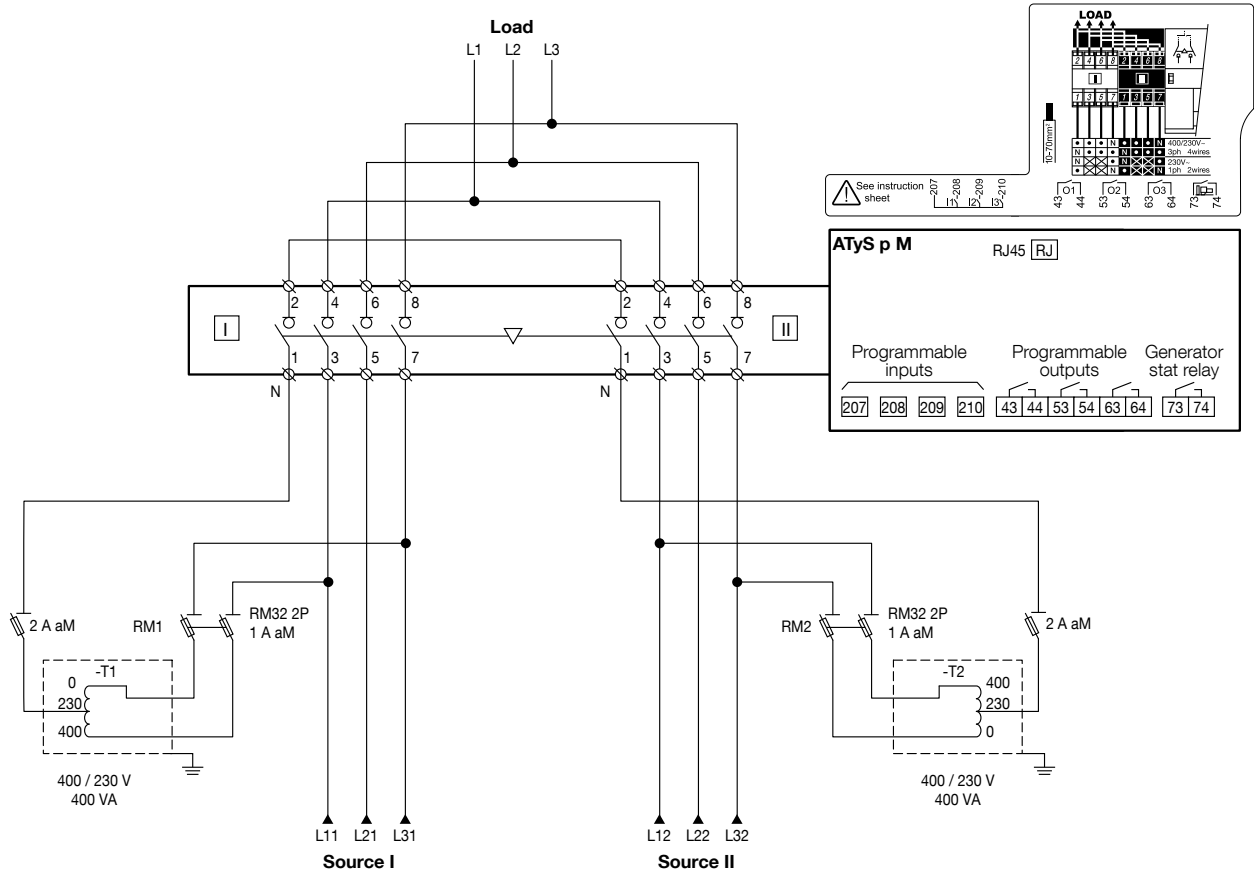

In case of use with an auto-transformer, the following wirings have to be respected in order to maintain the control of the rotation functionality:

Neutral on the left

		ATyS' terminals	
		Rotation ABC	Rotation ACB
Auto-transformer's terminals	0V	7	7
	230V	1	1
	400V	3	5

Neutral on the right

		ATyS' terminals	
		Rotation ABC	Rotation ACB
Auto-transformer's terminals	0V	1	1
	230V	7	7
	400V	5	3

# 12. CONNECTION OF CONTROL/COMMAND CIRCUITS



Switch to manual mode before connecting the product. (Front Auto/Manu cover open). The product is delivered in the 0 position.

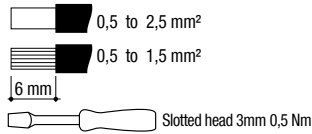
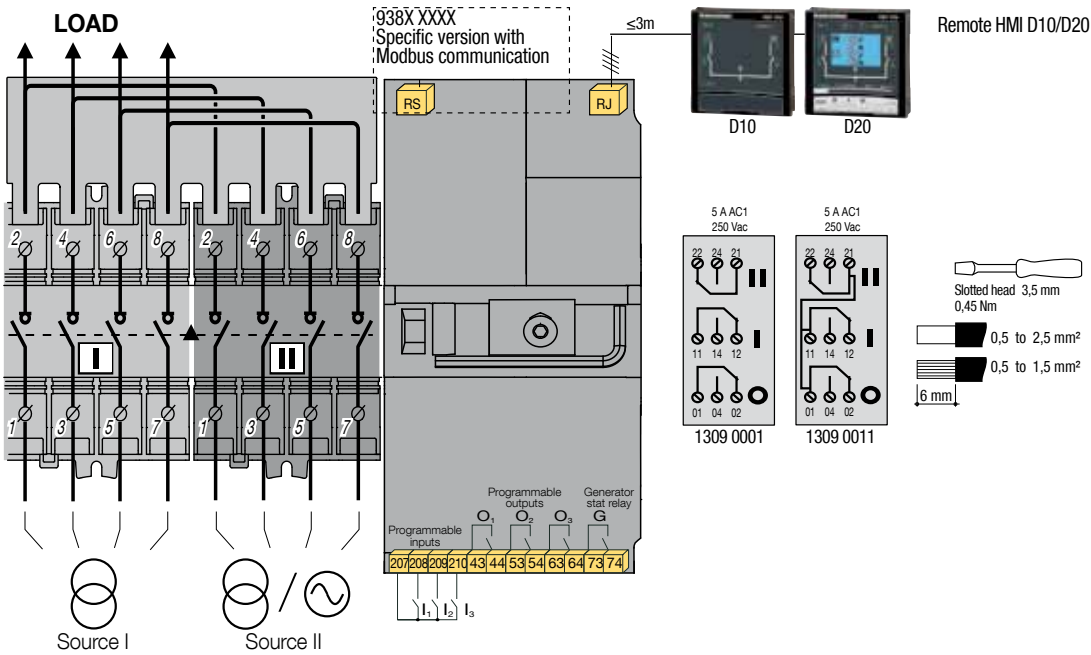

All pressure on the connector pins is to be avoided during wiring of the auxiliary cables



The product is delivered in the 0 position and in auto mode. Maximum control cables length = 10 m. In case of longer distance, use control relays.

Source must always be connected as show above.

Ensure that the product is in Manual Mode (front cover open).



See instruction sheet

207 208 209 210

11 12 13

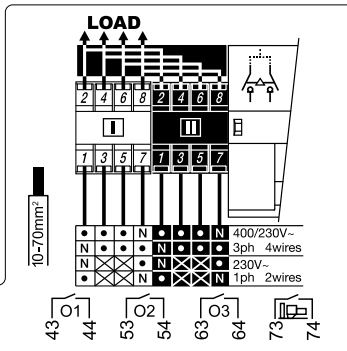

## 12.1. Terminal connectors designation

Type	Terminal no.	Description	Characteristics	Recommended connection cross-section
Inputs	207	Common point for inputs	Do not connect to any power supply Supply from the product	0.5 to 2.5 mm <sup>2</sup> (rigid)
	208	I1: programmable input		
	209	I2: programmable input		
	210	I3: programmable input		
Outputs	43/44	O1: programmable output	Resistive load 2A 30Vdc 0.5A 230Vac Pmax: 60W or 115VA Umax: 30Vdc or 230Vac	0.5 to 1.5 mm <sup>2</sup> (stranded)
	53/54	O2: programmable output		
	63/64	O3: programmable output		
	73/74	G: generator start signal		
Remote interface connection	RJ	ATyS D10/D20 human/machine interface	Maximum distance 3 m	RJ45 8/8 straight cable Cat. 5
Serial connection (specific version)	RS485	Connection RS485 0: interconnection of cable shielding upstream and downstream of RS485 bus -: negative terminal of RS485 bus +: positive terminal of RS485 bus	RS485 bus insulated	LiYCY shielded twisted pair, 0.5 to 2.5 mm <sup>2</sup>

Type	Terminal no.	Status of the contact	Description	Output characteristics	Recommended connection cross-section
Auxiliary contact block 1309 0001	11/12/14	11 — 14 12	Changeover switch in position I	250V AC 5A AC1 - 24VDC 2A AC13 - 250VAC - 2A	0.5 to 2.5 mm <sup>2</sup> (rigid)
	21/22/24	21 — 24 22	Changeover switch in position II		
	01/02/04	01 — 04 02	Changeover switch in position 0		
Auxiliary contact block 1309 0011	11/12/14	11 — 14 12	Changeover switch in position I	AC13 - 250VAC - 2A	0.5 to 1.5 mm <sup>2</sup> (stranded)
	21/22/24	21 — 24 22	Changeover switch in position II		
	01/02/04	01 — 04 02	Changeover switch in position 0		

## 12.2. Auxiliary contact operating schedule

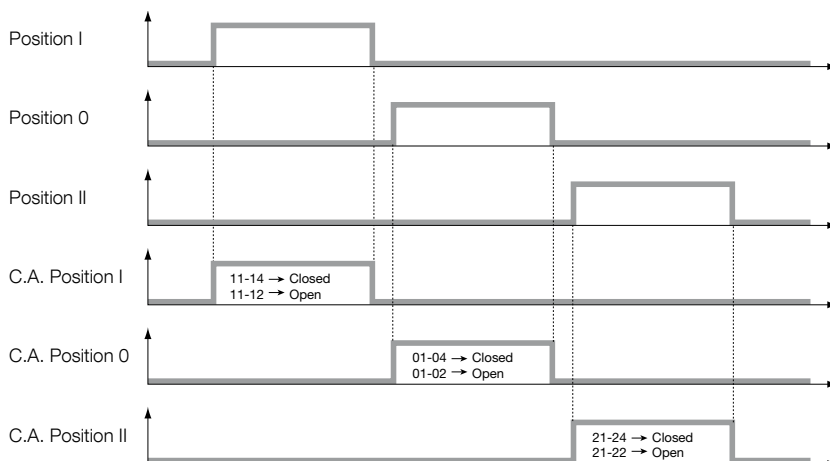

# 13. OPERATION

## 13.1. Presentation of the product interface

The LED signalling is only active when the product supply is on (supply LED lit)

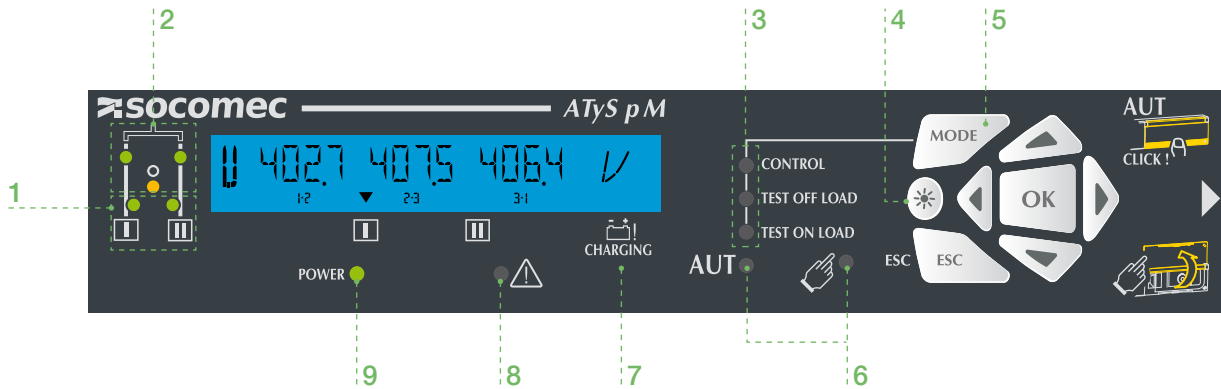

### 1. Availability of sources

- 2 green LEDs to indicate whether source I and/or source II are available (voltages and frequencies check).
  - LED lit = source available.
  - LED off = source unavailable.

### 2. Position of the switch

- 2 green LEDs
  - LED I lit = switch in position I
  - LED II lit = switch in position II
- 1 yellow LED
  - LED lit = switch in position 0

### 3. Test/Control modes

- 2 yellow LEDs for the test on load and test off load which are linked to the test mode selection button so as to facilitate selection.
- 1 yellow LED for the control function. The user may force the position of the switch.

### 4. LED test button

-  : Illuminates all LEDs to test their operation.

### 5. Mode button

- Test mode selection button.

### 6. Operating mode (Auto/Manu)

-  : 1 yellow LED for MANU mode active.
- AUT : 1 green LED for AUTO mode active.

### 7. Capacitor charge indicator

- Return to zero capacitor charge. When the indicator flashes, the RETURN to 0 function is unavailable.

### 8. Fault LED

- 1 red LED to indicate the status of the product control fault. Open and close the AUT/MANU cover after clearing the fault.

### 9. Power supply LED

- 1 green LED
  - Always off: power supply off or software error if the other indicators are operational (LED and Screen).
  - Always lit: product power supply on.

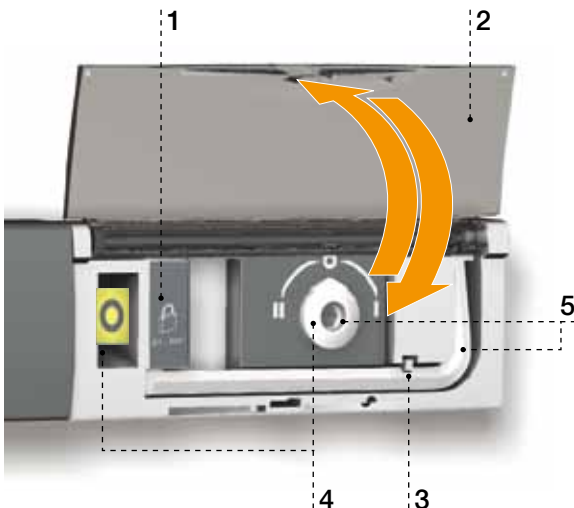

### 1. Locking

- Option to padlock using a 1 x 8 mm max. padlock.

### 2. AUT/MANU cover

- Open the cover to switch to manual mode.
- Close the cover to return to automatic (remote control) mode.
- Open and close the cover to clear faults.

### 3. Auto/Manual mode sensor



### 4. Switch position indicators

- Display of position I, 0, II.

### 5. Manual switching

- Insert the Allen key (5.0 mm) provided and turn to switch manually.
- Manual operation is not possible when padlocked.

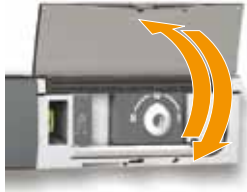
### 13.1.1. Reset

Operating fault reset	Reset Software (without loss of the settings)
Open and re-close the AUT/MAN cover	Insert a pointed tip into the orifice on the upper part of the product.
	

### 13.2. Manual mode

To access manual mode, open the Aut/Man cover or use the input INH.

Once manual mode is active (cover open) it is possible:

- To access the programming and display menus.
- To lock the changeover switch.
- To operate the changeover switch using the handle.
- To start the genset via the off load test.



As soon as manual mode is activated, all automatic actions are inhibited (except the starting order in case of mains loss).

In case of loss of source, if input INH is activated, the manual mode is also activated, but the genset start order isn't delivered.

The automatic cycle is relaunched 2 seconds after the switch from MAN to AUTO mode. During this time nothing happens, and the AUTO LED will flash.

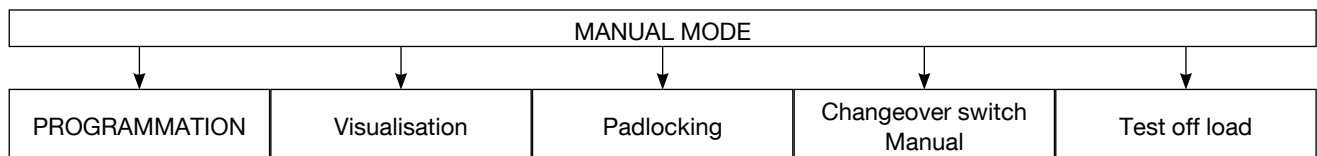

#### 13.2.1. Manual switching

Use the handle situated on the front panel under the cover to manoeuvre the changeover switch. To simplify the operation, it is advised to also use the handle extension that is delivered with the product.

Check the changeover switch position on the indicator situated on the front panel before making any operation.

- From position I, turn anti-clockwise to get to position 0
- From position 0, turn anti-clockwise to get to position II
- From position II, turn clockwise to get to position 0
- From position 0, turn clockwise to get to position I



Do not force the product (Max 8 Nm).

When the parameter MODE AUT is forced through programming, do not insert the operating handle into the manual operation housing.



### 13.3. Padlocking

Enables locking in the 0 position (factory configuration) or in positions I, 0 or II (user configurable). It is necessary to configure padlocking to all positions before installation as access to configuration is at the back of the product. Refer to section «8.1. Changing the padlocking configuration», page 18

Locking is only possible in manual mode (cover open).

Pull on the locking handle to enable the interlock. Lock by inserting a padlock into the orifice provided for this purpose.



## 13.4. Front keypad navigation and general information

### 13.4.1. Keypad

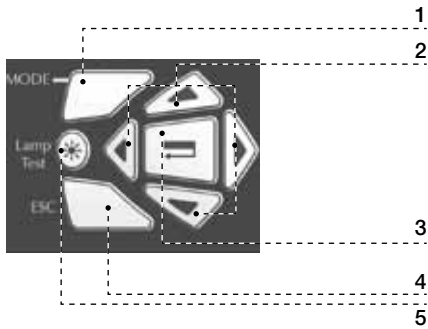

1. MODE key to shift between operation modes.
2. Navigation Keys to browse through the ATyS p menus without software.
3. Enter Key used to enter Prog Mode (Press and hold for 5 seconds) and to validate the settings programmed through the keypad.
4. ESC key used to escape from a specific screen up to the main menu.
5. Lamp test key to check the LED's and LCD screen.

### 13.4.2. Software version

The software version is displayed after the product has been switched on for the first time or when switched on after it has been off for several minutes (enabling its capacitors to fully discharge).

### 13.4.3. Display presentation

- Display mode is activated as soon as the device is switched on. It enables parameters visualisation whatever the functioning mode.
- The switchover cycles have priority over display mode, and display the time delay countdowns as soon as they are activated. Any value available in this mode is kept on the screen once displayed for 5 secs. After this time, or following a switchover cycle, the screen returns to source [1] phase-phase voltages display (1<sup>st</sup> screen in this mode).

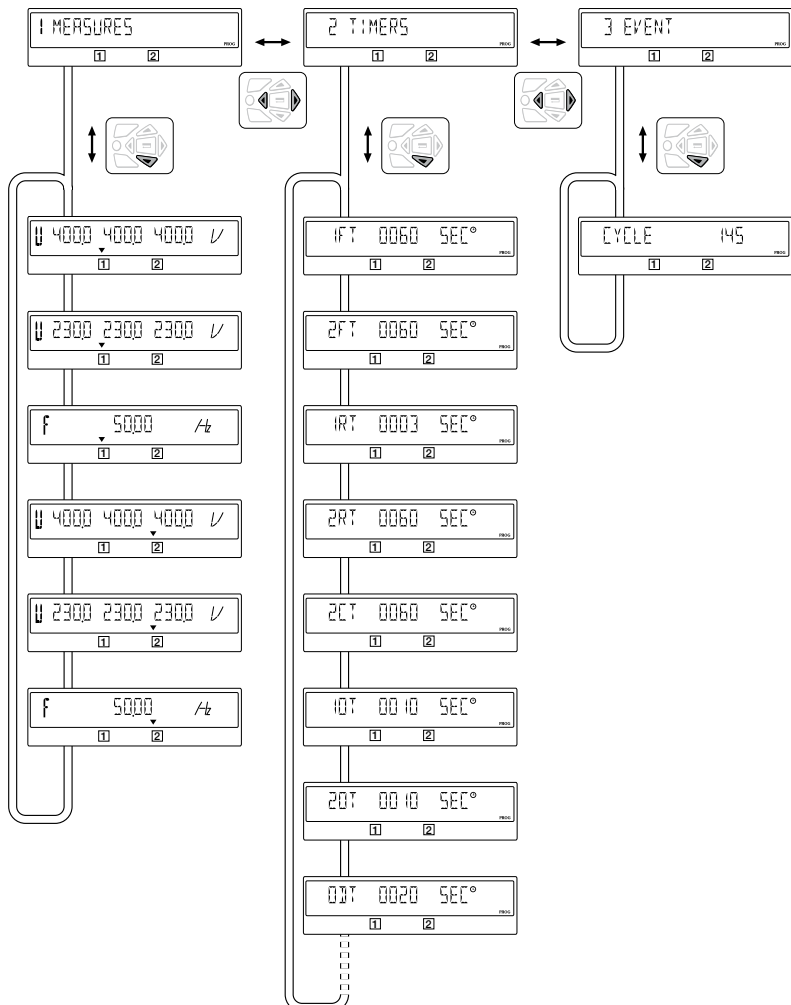

Dynamic display of the time delays has priority.



The alarms and faults status display also has priority.

## 13.4.4. Events

### 13.4.4.1. Encoding principle

#### Example

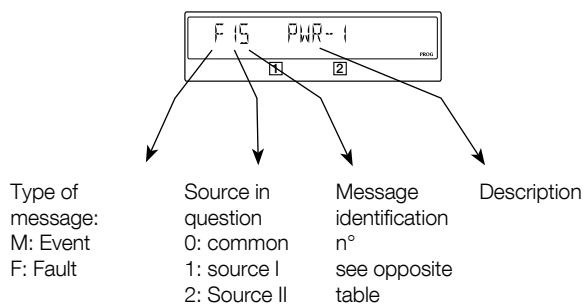





Message identification		
N°	Status message	Fault message
0	Manual switching	Duty cycle
1	Under-voltage	Fault
2	Over-voltage	Alarm
3	Under-frequency	Neutral wiring / Phase rotation mismatch
4	Over-frequency	Capacitor back to 0
5	Phase unbalance	Insufficient switchover power
6	Phase rotation	Position not reached

## 13.4.5. Events list

Message	Definition
M00 MANUAL ① ②	Manual switching
M11 UV1 ① ②	Under-voltage on source I
M21 UV2 ① ②	Under-voltage on source II
M12 OV1 ① ②	Over-voltage on source I
M22 OV2 ① ②	Over-voltage on source II
M13 UF1 ① ②	Under-frequency on source I
M23 UF2 ① ②	Under-frequency on source II

Message	Definition
M14 OF1 ① ②	Over-frequency on source I
M24 OF2 ① ②	Over-frequency on source II
M15 UNB1 ① ②	Phase unbalance on source I
M25 UNB2 ① ②	Phase unbalance on source II
M16 ROT1 ① ②	Incorrect direction of rotation on source I
M26 ROT2 ① ②	Incorrect direction of rotation on source II

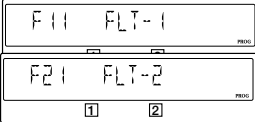
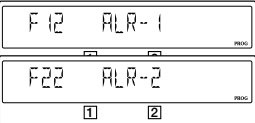
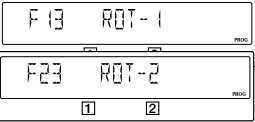
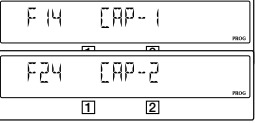
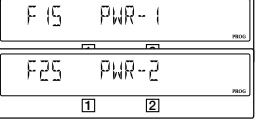
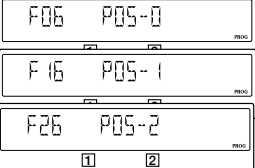
### 13.4.5.1. Error messages list

Error message	Definition	Action	Reset
	<b>Duty cycle</b> Limited number of operations in a defined period.	Wait 1 min. for the error message to disappear.	Automatic
	<b>Source I / source II</b> neutral wiring mismatch The neutral on source I is not wired on the same side as the neutral on source II.	Rewire one of the two sources. E.g. both neutrals on the left, or both neutrals on the right.	Open and then close the cover
	<b>Source I / source II</b> fault This fault only appears if input FT1/FT2 (see I-O Menu) and the parameter 2ND TRIP (see Setup Menu) are activated. Activation of this fault shifts the changeover switch to position 0.	Resolve the external problem that caused activation of input FT1/ FT2	Open and then close the cover or activate the RST input, if configured (see I-O Menu) or via RS485.
	<b>Alarm 1 / Alarm 2</b> This fault only appears if input AL1/ AL2 is activated (see I-O Menu).	Resolve the external problem that caused activation of input AL1/AL2. Once this is done, the error message will automatically disappear.	Automatic
	<b>Phase rotation fault on source I / source II</b> The phase rotation does not correspond to the ROT PH. variable in the Setup menu.	Either invert two phases on source I / source II, or change the status of the ROT PH. variable in the Setup menu, if both sources are faulty.	Automatic
	<b>Return to zero capacitor charging fault on source I / source II</b> Recharging malfunction of capacitor associated with source I / source II.	Provisional action: deactivate the RETURN 0 function in the Setup menu (Set to NO), or open the cover and operate manually. Then: contact your retailer.	Open and then close the cover
	<b>Insufficient switchover power on source I / source II</b> The power is insufficient to leave position II/I.	Supply the power (U,I) from source I or II for at least 20 secs or open the cover and operate manually.	Open and then close the cover
	<b>Fault position 0, I, II</b> Following an electric or automatic order, position 0 / I / II is not reached.	Provisional action: open the Aut/ Man cover and operate manually. Then: contact your retailer.	Change source status. Manual operation.
	<b>Source starting timeout II</b> If the genset does not start after the 2ST delay, the message will be sent.	Press the validation key. Check that 2ST is greater than 15s at 2AT.	Check the genset.

## 13.5. Programming

Whilst in manual mode check the wiring and installation. If ok power up the product.

This product must always be put into service by qualified and approved personal.

### 13.5.1. Programming with EasyConfig

Download Easy Config Software free from [www.socomec.com](http://www.socomec.com)

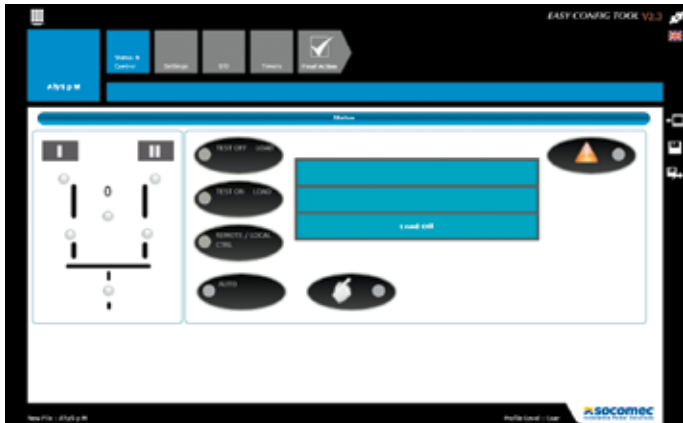

### 13.5.2. Product programming with the front keypad

Programming access is possible in Automatic mode, when the product is in position I with source I available, and in Manual mode whatever the position and the available source is.

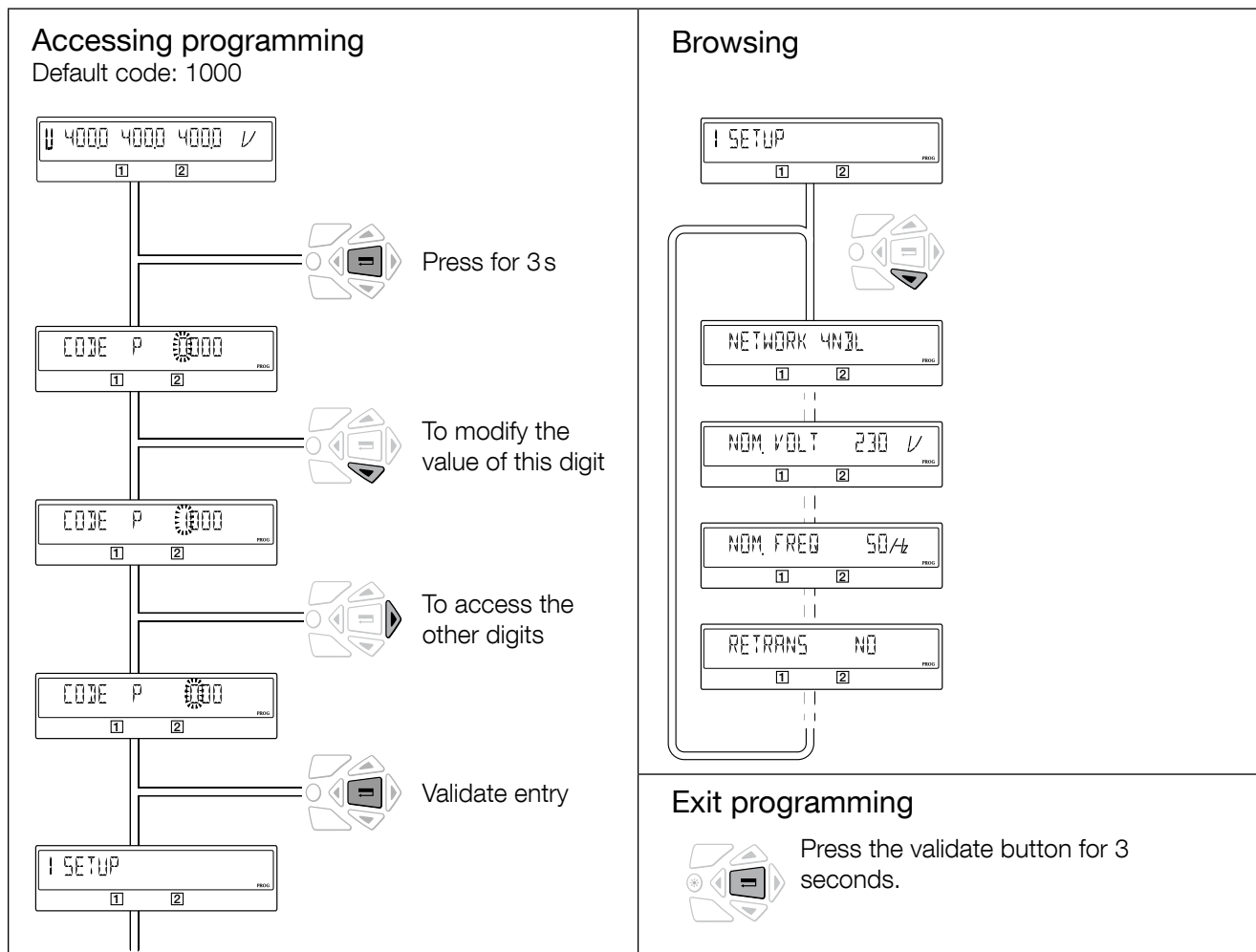

Note: To reset a fault indicator, see chapter «13.1.1. Reset», page 32

### 13.5.3. Programming mode

Depending on the type of application managed (Network-Network or Network-genset), some parameters in the SETUP menu may not be displayed.

For more details on the various operations, see sections «13. OPERATION», page 31, «13.2. Manual mode», page 32, «13.6. Automatic mode», page 54.

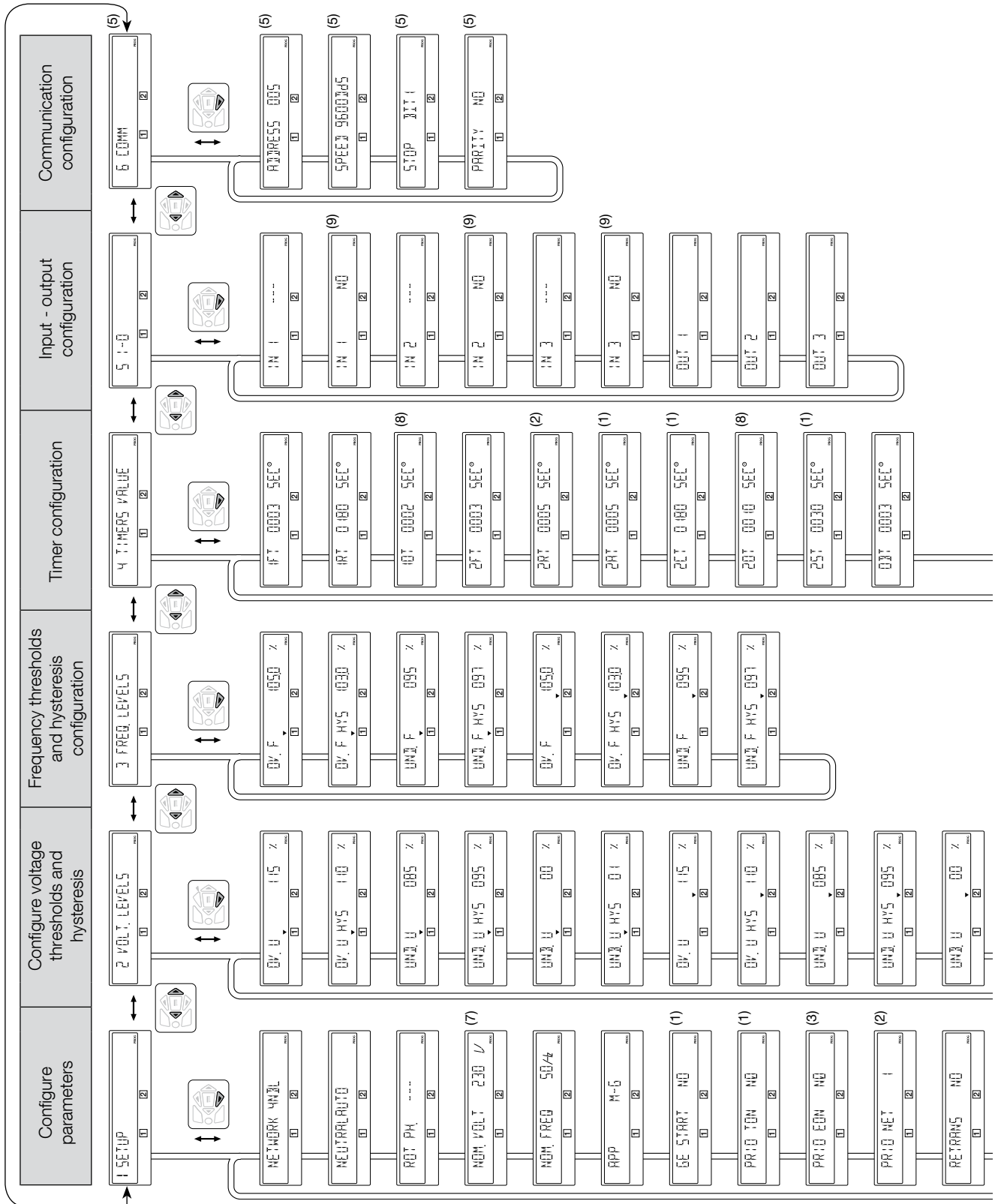

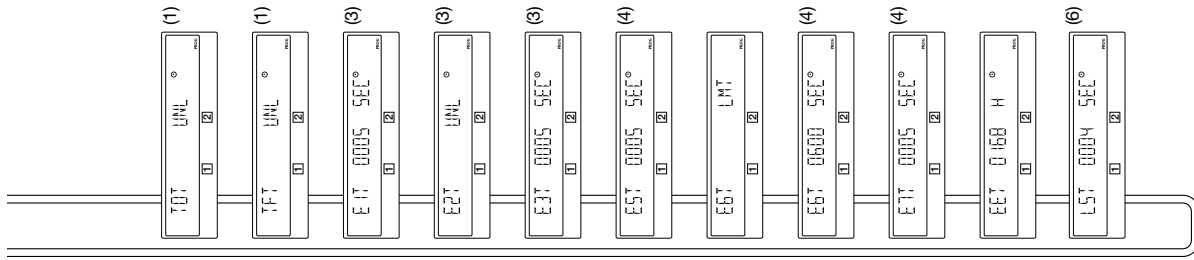
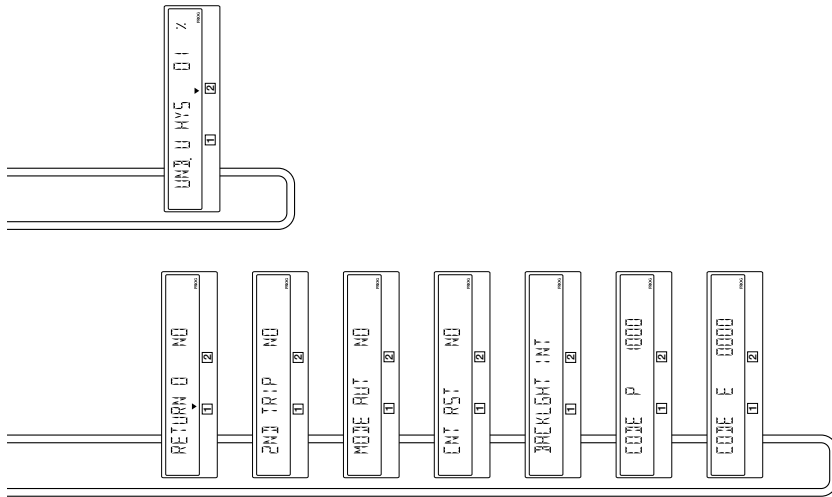

- (1) Only accessible if the Setup menu variable "APP" is at "M-G", see Setup Menu
- (2) Only accessible if the Setup menu variable "APP" is at "M-M", see Setup Menu
- (3) Only accessible if one of the inputs is EON, see I/O Menu
- (4) Only accessible if one of the inputs is EOF, see I/O Menu
- (5) Only on the COMM version, see description in the option section
- (6) Only accessible if one of the outputs is LSC, see I/O Menu
- (7) Default values: 230V for version 127/230 400V for version 230/400
- (8) only accessible when the "RETURN O" variable in the Setup menu is set to "YES", see SETUP menu.
- (9) Only accessible if the associated input is configured.

\* UNL = Unlimited



The entry point for programming mode is the SETUP menu.

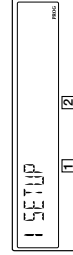

Parameters must always be adjusted and verified for compliance with the application. The default values are loaded as standard.

### 13.5.4. SETUP Menu

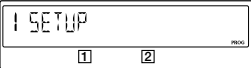
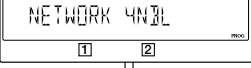
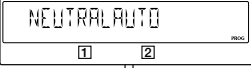
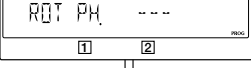
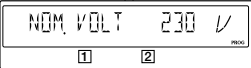
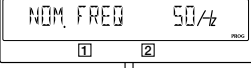
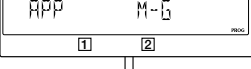
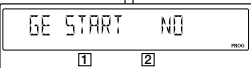
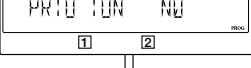
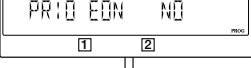
Definition	Adjustment range	Default values	M-G*	M-M*	
					
	NETWORK Type of network 4NBL/41NBL/-42NBL/ 1BL/3NBL (230/400V version) 4NBL/3NBL/2NBL/-2BL/42NBL (127/230V version)	4NBL	●	●	
	NEUTRAL Position of neutral - <b>AUTO</b> : neutral position is set automatically upon every power-up. This configuration cannot be used with a 3NBL 400 Vac network + auto transformer - <b>LEFT</b> : neutral must be connected on the left, i.e. to terminal 1 of each switch - <b>RIGHT</b> : neutral must be connected on the right, i.e. to terminal 7 of each switch	Auto LEFT RIGHT	Auto	●	●
	ROT PH. The phase rotation can be selected as clockwise (ACB) or anti-clockwise (ABC). It is also possible to just check for consistency of direction of rotation between 2 sources (---). To do so the 2 sources must be simultaneously present, for example during the initial wiring. (see next page)	ABC ACB ---	---	●	●
	NOM. VOLT Nominal phase-phase voltage. Except for 1BL and 41NBL networks, where it is nominal phase-neutral voltage.	from 180 to 480 Vac (230/400V version) from 180 to 280 Vac (127/230V version)	400 Vac (version 230/400V) 230 Vac (version 127/230V)	●	●
	NOM. FREQ Rated frequency	50 or 60 Hz	50 Hz	●	●
	APP Application type: - <b>M-G</b> : between a network and genset - <b>M-M</b> : between two networks	M-G M-M	M-G	●	●
	GE START "Generator start signal" output status at rest - <b>NO</b> : Normal Open - <b>NC</b> : Normal Close	NO NC	NO	●	
	PRIO TON In case of an On Load Test, if source II is no longer available you can - <b>NO</b> : exit the test and switch to source I - <b>YES</b> : stay in position II. The MSR input (see I-O Menu) has priority over this parameter	NO YES	NO	●	
	PRIO EON <sup>(1)</sup> In case of External On Load, if source II is no longer available you can - <b>NO</b> : exit the test and switch to source I - <b>YES</b> : stay in position II. The MSR input (see I-O Menu) has priority over this parameter	NO YES	NO	●	

\* M-G: network - genset application - M-M: network - network application  
 ● = parameter present on M-G and/or M-M applications

(1) This parameter is only accessible if a programmable input is configured with the EON variable (see I/O menu).

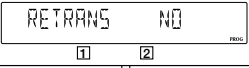
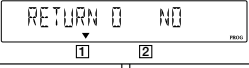
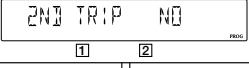
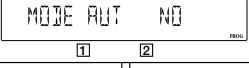
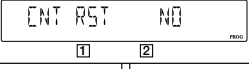
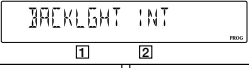
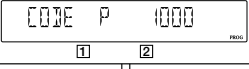
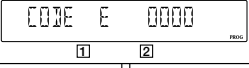

	Definition	Adjustment range	Default values	M-G*	M-M*
	PRIO NET This is to define the priority network: - <b>1</b> : network <b>I</b> has priority - <b>2</b> : network <b>II</b> has priority - <b>0</b> : no network has priority. The PRI input (see menu I-O) has priority over this parameter	1 2 0	1		●
	RETRANS Automatic retransfer inhibited - <b>NO</b> : automatic retransfer to the priority source - <b>YES</b> : "valid" must be pressed to execute the return	NO YES	NO	●	●
	RETURN 0 <sup>(1)</sup> In case of source failure, the product automatically switches over to 0 (after a 10T or 20T time delay) - <b>NO</b> : the product remains in position if the source is lost - <b>YES</b> : this function is activated If there are 2 sources down, the power reserve must be available to execute this function (see indicator on front panel)	NO YES	NO	●	●
	2ND TRIP <sup>(2)</sup> This function makes it possible to wait for the power reserve to become available before leaving position 0 tripping . - <b>NO</b> : Return to the source without waiting for the reserve to be fully charged - <b>YES</b> : Wait for the reserve to be fully charged before returning to the source. A second trip will therefore be immediately available	NO YES	NO	●	●
	MOD AUT AUTO mode forced, in spite of cover not being closed.	NO YES	NO	●	●
	CNT RST Switchover counter reset (number of operations) Returns to NO after reset	NO YES	NO	●	●
	BACKLIGHT The screen backlighting can be set to: - <b>OFF</b> : always off - <b>ON</b> : always lit - <b>INT</b> : lit during operating sequences and then turned off after 30 seconds' inactivity on the keypad	OFF ON INT	INT	●	●
	CODE P Modifying input in Programming mode code	0000 to 9999	1000	●	●
	CODE E Modifying input code in Operating mode	0000 to 9999	0000	●	●

\* M-G: Mains - genset application - M-M: Mains - Mains application  
● = parameter present on M-G and/or M-M applications

- (1) The RETURN to 0 function, after loss of source **I** or **II** opens the switch (I=>0 or II=>0) of the source in question after a time delay (10T or 20T). For instance, this solution provides the possibility of opening the switch after a short-circuit. This also makes it possible to restart the genset after a fault, without being connected to the load.
- (2) The 2nd TRIP parameter is associated with the RETURN to 0 function, as the latter requires a power reserve for the changeover. So to execute a second trip, you need to wait for this power reserve to recharge.

### 13.5.5. Phase rotation check

This functionality checks the consistency of phase rotation i.e. of the wiring prior to commissioning.

Example: If the parameter ROT PH = ABC:

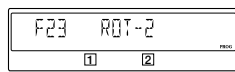
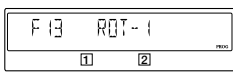
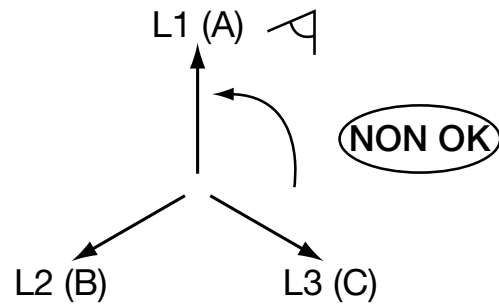
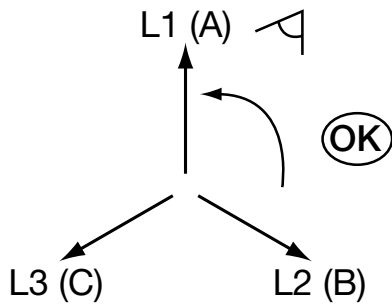

Display  or  depending on the non-compliant source

(Rotation check on sources  and .

	<b>WARNING</b>	Function available on both sources in case of 4NBL/4BL or 3NBL/3BL type of network and only on source <input type="checkbox"/> in case of 41NBL or 42NBL network.
---	----------------	---

If the ROT PH parameter = - - -, the test is carried out when the two sources are present at the same time. It is therefore recommended to have both sources present during commissioning.

### 13.5.6. VOLT. LEVELS Menu

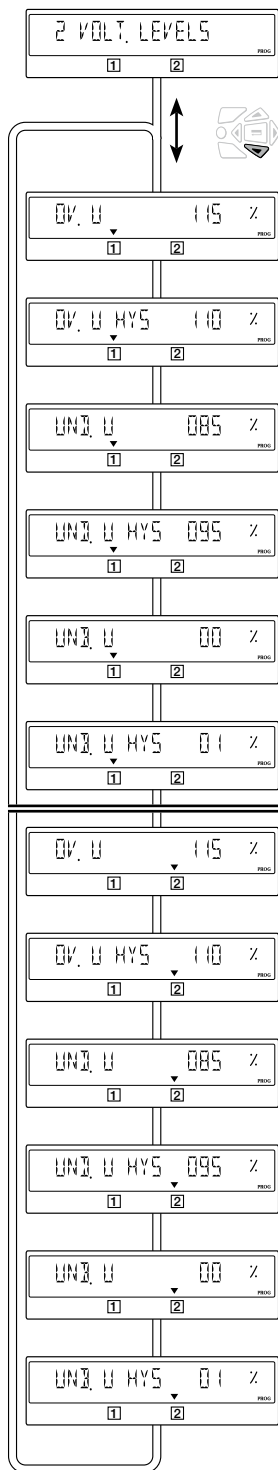

Definition		Adjustment range*	Default values *	
OV.U	Overvoltage threshold source <b>I</b>	102 - 130 %	115 %	Source <b>I</b>
OV.U HYS	Source <b>I</b> over-voltage hysteresis	101 - 119 %	110 %	
UND.U	Undervoltage threshold source <b>I</b>	60 - 98 %	85 %	
UND.U HYS	Source <b>I</b> under-voltage hysteresis	61 - 99 %	95 %	
UNB.U	Phase unbalance threshold <b>I</b> (see next paragraph)	00 - 30 %	00 %	
UNB.U HYS	Hysteresis unbalance detection <b>I</b> (see next paragraph)	01 - 29 %	01 %	
OV.U	Overvoltage threshold source <b>II</b>	102 - 130 %	115 %	Source <b>II</b>
OV.U HYS	Source <b>II</b> over-voltage hysteresis	101 - 119 %	110 %	
UND.U	Undervoltage thresholds source <b>II</b>	60 - 98 %	85 %	
UND.U HYS	Source <b>II</b> under-voltage hysteresis	61 - 99 %	95 %	
UNB.U	Phase unbalance threshold <b>II</b> (see next paragraph)	00 - 30 %	00 %	
UNB.U HYS	Hysteresis unbalance detection <b>II</b> (see next paragraph)	01 - 29%	01%	

\* As percentages of Unom in case of over and undervoltage.  
As percentages of Uavg in case of unbalances.

Measurement accuracy: Voltage: 1 %

### 13.5.7. Over-voltage and under-voltage

The thresholds and hystereses are defined as percentages of nominal voltage.  
The hystereses defines a return to normal levels following an under-voltage or over-voltage.

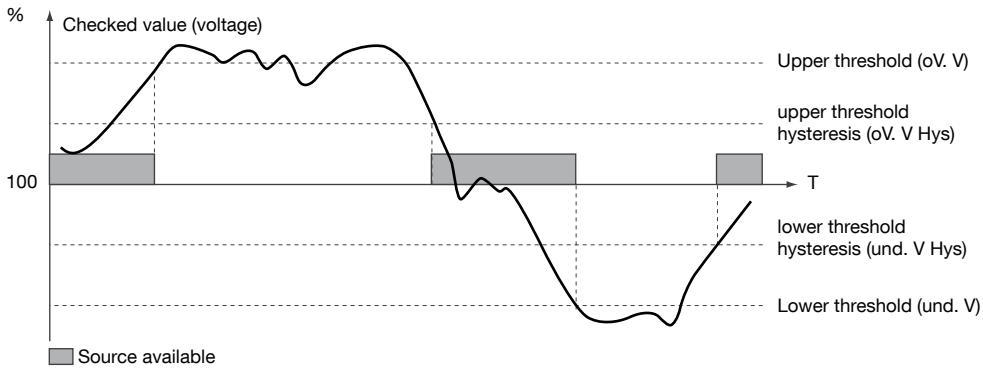

#### 13.5.7.1. Voltage unbalance measurement

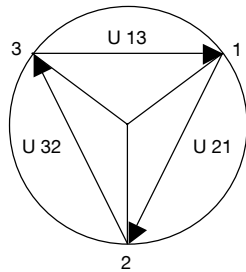

Balanced network

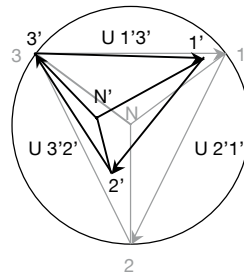

Unbalanced network

The unbalance reading is derived from the formula below

$$U_{nba} = \frac{\max(|U_{12} - U_{avg}|, |U_{23} - U_{avg}|, |U_{31} - U_{avg}|)}{U_{avg}} \quad \text{with} \quad U_{avg} = \frac{U_{12} + U_{23} + U_{31}}{3}$$

Example of an unbalanced network:  $U_{12} = 352 \text{ Vac}$

$U_{23} = 400 \text{ Vac}$      $U_{31} = 370 \text{ Vac}$

$$U_{avg} = (352+400+370)/3 = 374 \text{ V AC}$$

$$U_{nba} = 26/374 = 0.069 \Rightarrow \text{Unbalance threshold rate } 7\%$$

### 13.5.8. FREQ. LEVELS Menu

Definition		Adjustment range*	Default values *	
OV.F	Over-frequency threshold source <b>I</b>	101 - 120 %	105 %	Source <b>I</b>
OV.F HYS	Source <b>I</b> over-frequency hysteresis	100.5 - 119.5%	103 %	
UND.F	Under-frequency threshold source <b>I</b>	60 - 99 %	95 %	
UND.F HYS	Source <b>I</b> under-frequency hysteresis	60.5 - 99.5 %	97 %	
OV.F	Over-frequency threshold source <b>II</b>	101 % - 120 %	105 %	Source <b>II</b>
OV.F HYS	Source <b>II</b> over-frequency hysteresis	100.5 - 119.5 %	103 %	
UND.F	Under-frequency threshold source <b>II</b>	60 - 99 %	95 %	
UND.F HYS	Source <b>II</b> under-frequency hysteresis	60.5 - 99.5 %	97 %	

\* As percentages of Fnom

• **Under-frequency or over-frequency**

The thresholds and hystereses are defined as a percentage of nominal frequency.  
 The hystereses defines a return to normal levels following an under-frequency or over-frequency.  
 Measurement accuracy: Frequency: 0.1 %

#### 13.5.8.1. Under-frequency or over-frequency

The thresholds and hysteresis are defined as a percentage of nominal frequency.  
 The hysteresis defines a return to normal levels following an under-frequency or over-frequency.

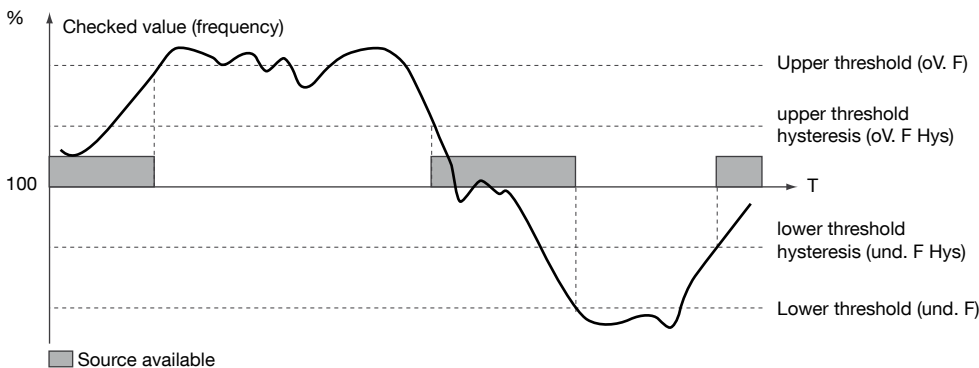

### 13.5.9. TIMERS Menu

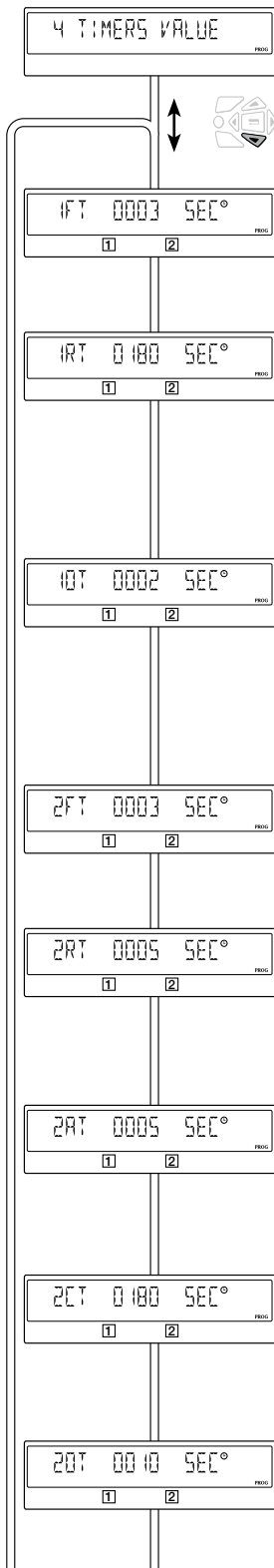

Definition		Adjustment range	Default values	M-G*	M-M*
1FT	Source <b>[1]</b> loss time delay (source <b>[1]</b> Failure Timer) When source <b>[1]</b> disappears, 1FT is started. If source <b>[1]</b> is restored before the end of 1FT, the switchover cycle is not engaged.	from 0 to 60 secs	3 s	●	●
1RT	Source <b>[1]</b> restoration time delay (source <b>[1]</b> Return Timer) When source <b>[1]</b> reappears, 1RT is started. At the end of 1RT, source <b>[1]</b> is considered present. If source <b>[1]</b> disappears before the end of 1RT, the switchover is not executed. If the replacement source disappears during 1RT, the latter dynamically and temporarily adopts the 3 s setting value.	from 0 to 3600 secs	180 s	●	●
10T	Return to zero time delay from source <b>[1]</b> (source <b>[1]</b> to <b>0</b> Timer) Only accessible if the Setup menu parameter RETURN 0 is activated. Waiting time delay following source <b>[1]</b> failure, before switchover to position 0. This time delay avoids opening directly to short-circuit or load impact.	from 0 to 10 secs	2 s	●	●
2FT	Source loss time delay <b>[II]</b> (source <b>[II]</b> Failure Timer) When source <b>[II]</b> disappears, 2FT is started. If source <b>[II]</b> is restored before the end of 2FT, the switchover cycle is not engaged.	from 0 to 60 secs	3 s		●
2RT	Source <b>[II]</b> restoration time delay (source <b>[II]</b> Return Timer) When source <b>[II]</b> reappears, 2RT is started. At the end of 2RT, source <b>[II]</b> is considered present. If source <b>[II]</b> disappears before the end of 2RT, the switchover is not executed.	from 0 to 3600 secs	5 s		●
2AT	Stabilisation time delay (source <b>[II]</b> Available Timer) Stabilisation time delay for voltage and frequency on Source <b>[II]</b> . The time delay starts as soon as the source voltage is above the hysteresis value. This time delay must be completed to enable transfer to Source <b>[II]</b>	from 0 to 3600 secs	5 s	●	
2CT	genset cooling time (source <b>[II]</b> ) (source <b>[II]</b> Cool Down Timer) Following a switchover sequence, and after returning to source <b>[1]</b> , source <b>[II]</b> (genset) is kept running for 2CT to enable it to cool down.	from 0 to 600 secs	180 s	●	
20T	Return to zero time delay from source <b>[II]</b> (source <b>[II]</b> to <b>0</b> Timer) Only accessible if the Setup menu parameter RETURN 0 is activated. Waiting time delay following source <b>[II]</b> failure, before switchover to position 0. This time delay avoids opening directly to short-circuit or load impact.	from 0 to 10 secs	10 s	●	●

\* M-G: Mains - genset application - M-M: Mains - Mains application  
● = timer present on M-G and/or M-M applications

				M-G*	M-M*	
	2ST	Genset starting timeout delay (source <input type="checkbox"/> ) (source <input type="checkbox"/> Start Timer) Time delay started at the same time as the starting request. If after 2ST source <input type="checkbox"/> (genset) has not started, an error message is displayed «FAIL START».	from 0 to 600 secs	30 s	●	
	ODT	Minimum off time delay (0 Dead Timer) This is the minimum load supply down time, possibly with stop in position 0, so as to enable residual voltages generated by the load (engine type) to disappear.	from 0 to 20 secs	3 s	●	●
	TOT	"On Load Test" duration time delay (Test On Load Timer) This time delay defines the On Load Test time. It starts when the Test is initiated. The return to the network takes place at the end of TOT.	UNL (unlimited)/ LMT (from 10 to 1800 secs)	UNL	●	
	TFT	"Off Load test" time delay (Test off Load Timer) This time delay defines the Off Load Test duration.	UNL (unlimited) / LMT (from 10 to 1800s)	UNL	●	
	E1T (1)	"On Load external operation" request time delay (start) This time delay starts at the same time as the EON order. At the end of this time delay, the genset starting order is sent. Then when the genset is available, the transfer on source <input type="checkbox"/> takes place.	from 0 to 1800 secs	5 s	●	
	E2T (1)	"On Load external operation" request time delay (duration) This time delay defines the EON order time.	UNL (unlimited)/ LMT (from 10 to 1800 secs)	UNL	●	
	E3T (1)	"On Load external operation" request time delay (End) This time delay is counted from the end of the EON order, and only after this time delay is the switchover to source <input type="checkbox"/> is executed.	from 0 to 1800 secs	5 s	●	
	E5T (2)	"Off load external operation" request time delay (start) This time delay starts at the same time as the EOF order. At the end of this time delay, the genset starting order is sent.	from 0 to 1800 secs	5 s	●	
	E6T (2)	"Off load external operation" request time delay (duration) This time delay defines the EOF order time.	UNL (unlimited)/ LMT (from 10 to 1800 secs)	LMT 600 s	●	
	E7T (2)	"Off load external operation" request time delay (end) This time delay is counted from the end of the EOF order, and only after this time delay will time delay 2CT start, to stop the genset.	from 0 to 1800 secs	5 s	●	
	EET	Programming genset starting time delay, following its last stop after an on load functioning. At its end, the output EES will be activated. (After 160H, derived from ± 20s).	from 0 to 1100h	168h	●	
	LST	Load shedding time delay Load Shedding Timer This time delay corresponds to the time available to perform the load shedding operation.	from 0 to 60 secs	4 s	●	●

\* M-G: Mains - genset application - M-M: Mains - Mains application  
● = timer present on M-G and/or M-M applications

(1): these time delays are only accessible and configurable if at least one programmable input is configured with the variable EON (see I/O menu)  
(2): these time delays are only accessible and configurable if at least one programmable input is configured with the variable EON (see I/O menu)

### 13.5.10. I-O menu

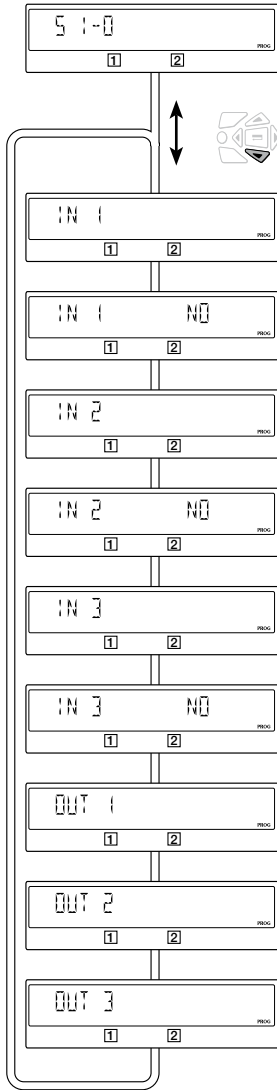

Variable	Definition	Adjustment range	Default value
IN 1	Input 1	See table following pages	/
IN 1	Input 1 status	NO or NC	NO
IN 2	Input 2	See table following pages	/
IN 2	Input 2 status	NO or NC	NO
IN 3	Input 3	See table following pages	/
IN 3	Input 3 status	NO or NC	NO
Out 1	Output 1	See table following pages	/
Out 2	Output 2	See table following pages	/
Out 3	Output 3	See table following pages	/

NO: Normal Open (Open)  
 NC: Normal Close (Closed)



### 13.5.10.1. Inputs description

		M-G*	M-M*
Automatic operation inhibited			
INH	Automatic operation inhibited, same function as manual mode. All Automatic operation is then inhibited. Start gen state will not change even if the network is lost.	●	●
Test on load			
TON	Activates on load test. Retransfer remains locked until contact is deactivated.	●	
Test off load			
TOF	Activates off load test (genset started and stopped).	●	
External on load operation request, delayable			
EON	Activates an operating cycle depending on time delays E1T, E2T, E3T. These time delays have to be set in the TIMERS menu (operation: see graphs below).	●	
External off load operation request, delayable			
EOF	Activates «Start Gen» contact (genset starting) (source II) according to time delays E5T, E6T, E7T. These time delays have to be set in the TIMERS menu (operation: the same as the input EON, without load switchover).	●	
Forcing to source II (genset) in TON and EON mode			
MSR	During an on load test or a delayable external on load operation request, validating the input enables you to remain in back-up position in all circumstances (loss of this source), as long as the test is active. This input has priority over parameters PRIO TON and PRIO EON.	●	
Confirms return to priority source			
RTC	Remote manual transfer. Transfer back to source I initiated upon the contact closing. Same function as the variable "RETRANS" cleared with the keypad. This SETUP menu variable must also be at YES to validate operation by the input.	●	●
Source priority			
PRI	Defines the priority source. If this entry is activated, source II has priority, otherwise source I has priority. It is equivalent to, but with priority over, the SETUP menu parameter PRIO NET.		●
Stabilisation time delay bypass			
SS1 / SS2	Remote transfer check. It is possible to initiate the transfer from source I to source II (and vice versa) before the end of the time delay 1RT/2RT/2AT countdown, depending on the application type. If the latter is set to its maximum value, it is possible to transfer by activating the contact (front of one second).	●	●
Positions I, II and 0 command			
PS1/ PS2/ PS0	Position I / position II / position 0 command. When the command disappears the product returns to automatic mode. The last command received has priority. Command 0 has priority over commands I and II. NB, switching to Pos I (Pos II) is only possible if source I (source II) is present.	●	●
Source I / source II alarm			
AL1 / AL2	Informs the user by flashing the fault LED and indicating F12 ALR - 1 / F22 ALR - 2 on the screen. This message disappears along with the alarm. <i>L'entrée simule également la perte de la source concernée, le démarrage du groupe électrogène le cas échéant et le basculement sur l'autre source si celle-ci est disponible.</i>	●	●
Source I / source II fault			
FT1 / FT2	Informs the user by flashing the fault LED and indicating F11 FLT - 1 / F21 FLT - 2 on the screen. Disappears after validation and reset (by activating RST input, opening and then closing the cover or via RS485). Immediately shifts the changeover switch to position 0, without 10T or 20T time delay. NB, only works if the 2nd TRIP parameter is activated.	●	●
Source I / source II external availability signal			
OA1 / OA2	Availability signal for source I (source II). This input is used instead of the voltage and frequency measurement	●	●
Fault reset			
RST	Reinitialises a fault	●	●
Load shedding bypass			
LSI (1)	This input bypasses the LST time delay, (signal indicating correct load shedding).	●	●

\* M-G: Mains - genset application - M-M: Mains - Mains application

(1): this output is only accessible if a programmable input is configured with the EON variable (see I/O menu)

## Explanation of how EON works:

E2T when set as Limited

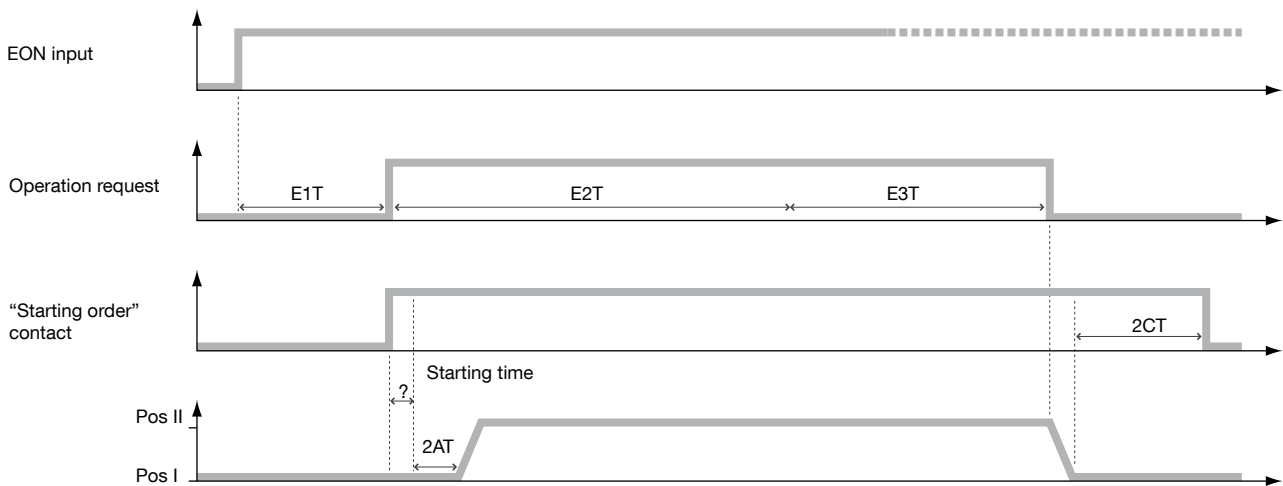

E2T takes priority over EON if E2T is set as LIM (Limited)

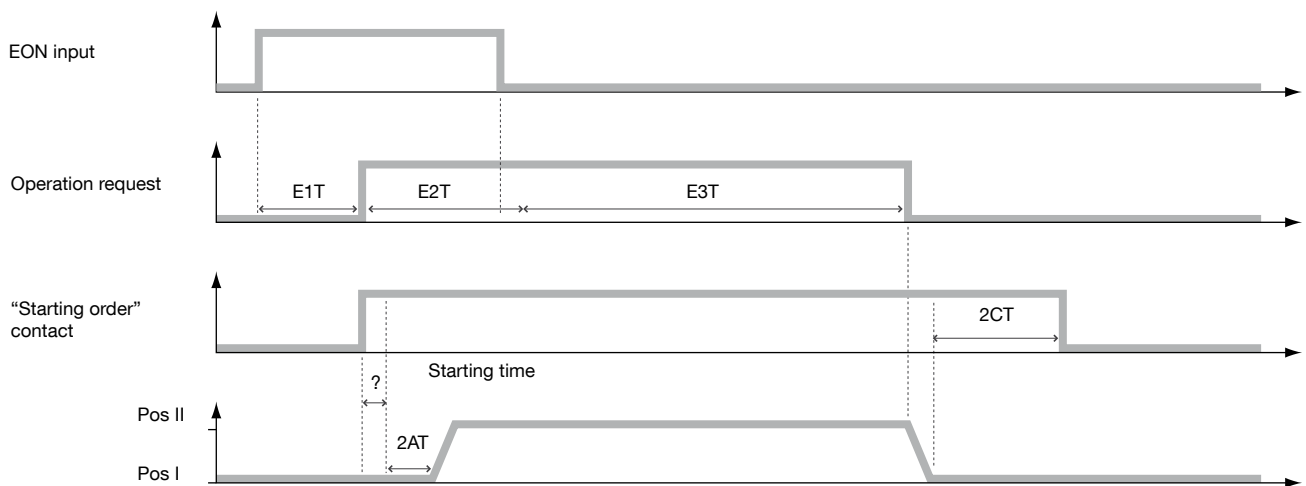

EON takes priority over E2T if E2T is set as UNL (Unlimited)

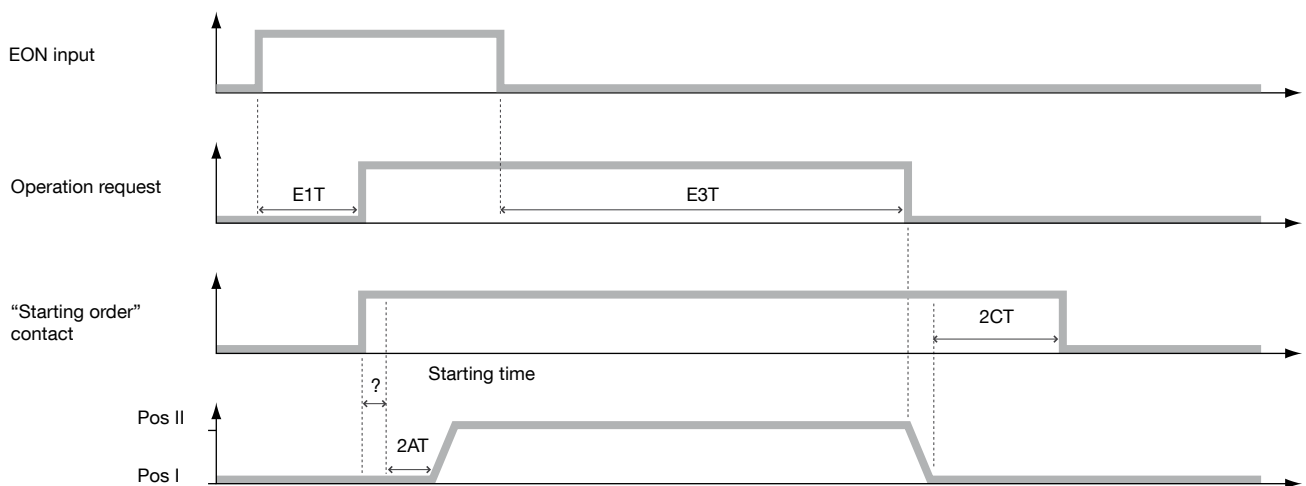

### 13.5.10.2. Outputs description

		M-G*	M-M*
Source available			
S1A /S2A	Source <input type="checkbox"/> / Source <input type="checkbox"/> available. Output activated (closed) if source <input type="checkbox"/> / source <input type="checkbox"/> is within the defined setting ranges (same function as LED on front panel).	●	●
At least one source available			
SCA	Source <input type="checkbox"/> or <input type="checkbox"/> available. Output activated (closed) if at least one of the 2 sources is within the defined settings ranges.	●	●
Position auxiliary contact			
AC1/AC2/ AC0	Outputs activated respectively when product is in position I / position II / position 0.	●	●
Load supplied by source <input type="checkbox"/> / by source <input type="checkbox"/>			
LO1 / LO2	Indicates which source is supplying the load. Output LO1 / LO2 activated if the 2 following conditions are simultaneously validated: position I / position II is closed and source <input type="checkbox"/> / source <input type="checkbox"/> is available (LO1 = AC1 et S1A / LO2 = AC2 et S2A). position I / position II is closed and source / source is available (LO1 = AC1 and S1A / LO2 = AC2 and S2A).	●	●
Load shedding command			
LSC	Load shedding relay. Initiates a load shedding action before transfer to back-up source, and then reloading after restoration. Operations see following pages.	●	●
Fault summary			
FLT	Output activated (closed) if at least one fault (internal or transferred external) is activated.	●	●
Product operational (no fault + product in Auto mode)			
POP	Output activated (closed) if the product is deemed "operational" i.e. it is in AUT mode, the supply is present and no fault is detected.	●	●
Input copy			
CP1/CP2/ CP3	The output adopts the same status as input 1 / input 2 / input 3. Same function as relaying.	●	●
Synthesis TON			
TOS	Output is activated in case of test on load.	●	
Synthesis EON			
EOS	Output is activated in case of external on load.	●	
Synthesis TON and EON			
ROS	Output is activated in case of test on load or external on load.	●	
Output parameter for programmed start of the genset (Linked to EET time delay)			
EES	This parameter activates an output that can be linked to the inputs EON or EOF in order to test the genset during a time defined respectively by (E1T, E2T, E3T) and (E5T, E6T, E7T).	●	

\* M-G: network - genset application - M-M: network - network application

## Explanation of how LSC works

If output LSC is selected, (load shedding before transfer request), the associated time delay LST (maximum duration of the load shedding) must be programmed in the Timers Menu.

### Scenario 1 with LSI active

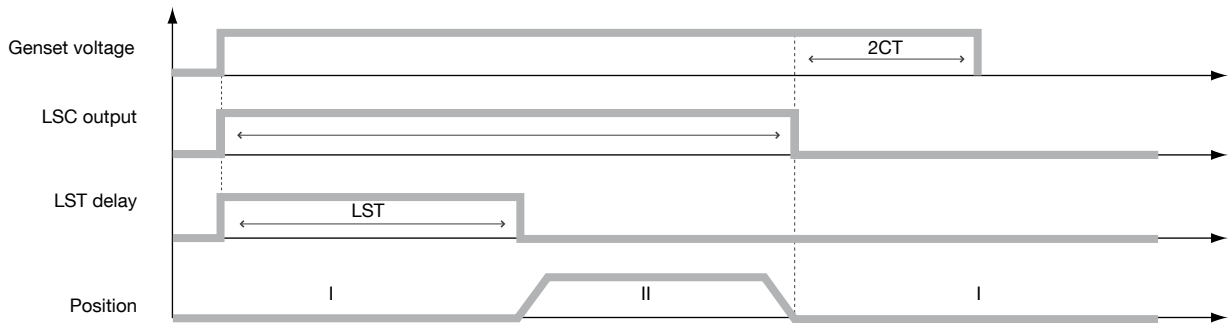

### Scenario 2: LSI Input not activated

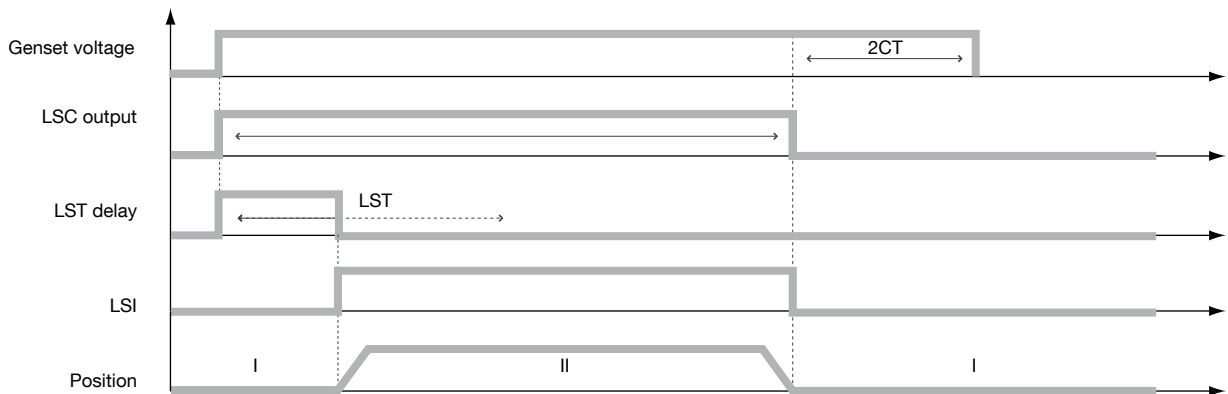

### Genset programming start

In some applications (genset without battery charger), it is asked to start the genset after X hours (EET) of inactivity (except for TOF) in order to enable the battery to charge. According to the customer needs, the corresponding output (EES) can be connected either to the input EON (External on load) or to the input EOF (External off load). These tests EON and EOF are programmable respectively via (E1T, E2T, E3T) and (E5T, E6T, E7T).

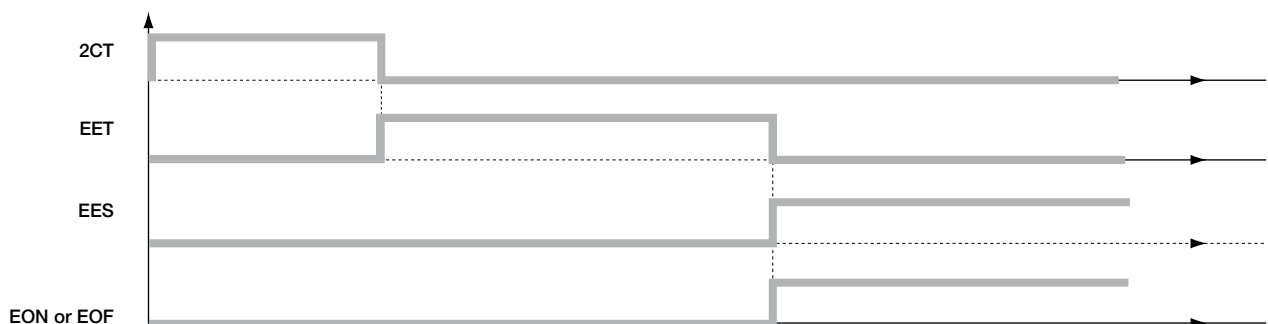

### 13.5.11. COMM Menu

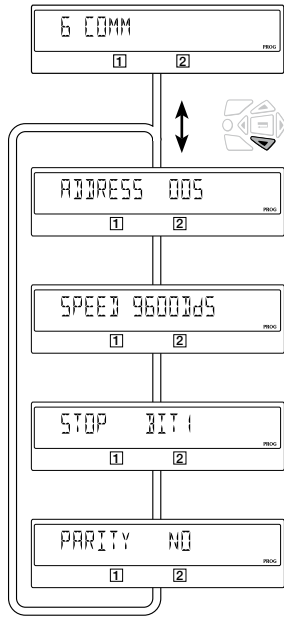

Variable	Definition	Adjustment range	Default value
Address	Address of the device	1 to 255	5
Speed	Communication speed	2400, 4800 9600, 19200 38400	9600
Stop bit		1, 2	1
Parity bit	NO: no Parity bit ODD: Odd EVEN: Even	NO, ODD, EVE	NO



Only available on version with Comm.

Detailed explanation in chapter «13.9. Communication (optional 9383 xxxx units only)», page 65

## 13.6. Automatic mode

Close the cover to enter automatic mode. Make sure that the changeover switch is in automatic mode (AUT LED lit).

### 13.6.1. Sealable Auto/Manual cover

Auto/Manu mode can be protected by sealing the standard Auto/Manu cover as shown.

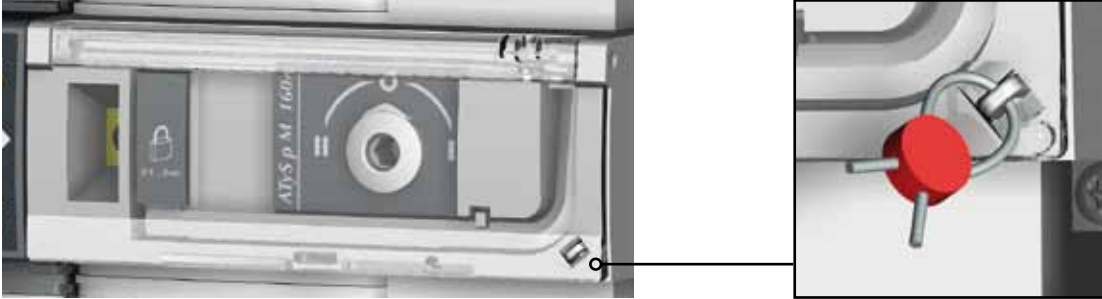

### 13.6.2. Possible actions

Once in automatic mode, it is possible to:

- Access the programming (mains present) and display menus.
- Run an on load or off load test.
- Run a source  / source  loss sequence.
- Start a source  / source  restoration sequence.

### 4.6.2. Manual & Automatic Mode / Mains restoration conditions

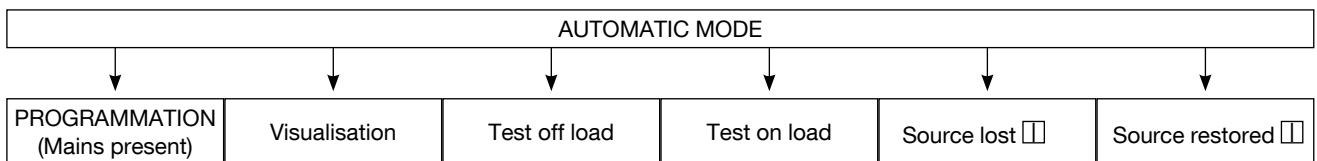

- Automatic mode becomes active 2 seconds after switching from manual to automatic mode.
- Source  source  voltages and frequencies are checked to define the changeover switch's new stable status.
- The same automatic mode recognition sequence must be executed following a power-off and a complete discharge of the power reserves.

### 13.6.3. Priority source loss sequence (stable position) in M-G application

#### Configuration

- APP = M-G : Mains - genset application
- RETURN 0 = NO: changeover switch remains in position during loss of the source

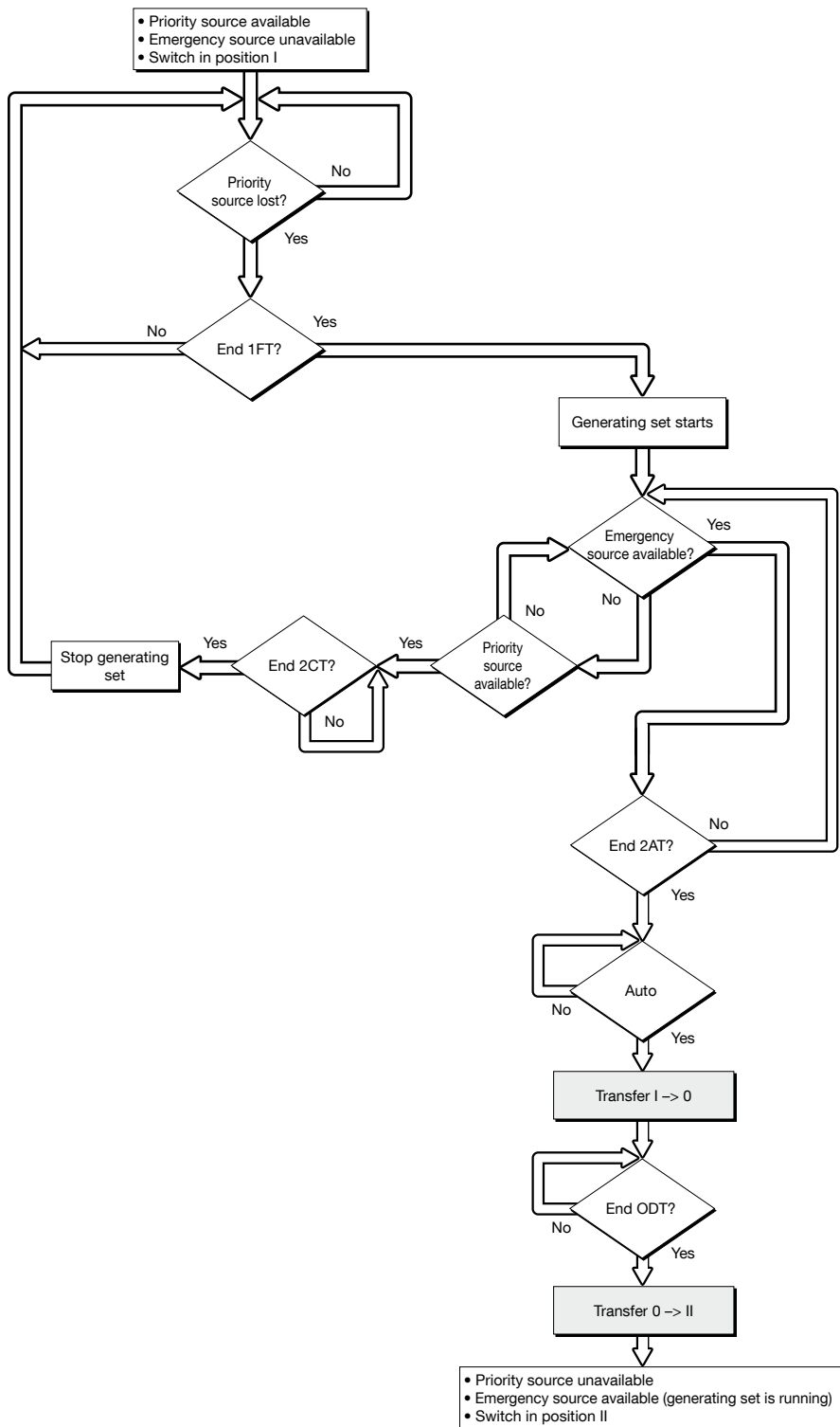

### 13.6.4. Priority source loss and restoration sequence (stable position) in M-M application

#### Configuration

- APP = M-M: Mains - Mains application
- RETURN 0 = NO: changeover switch remains in position upon loss of the source

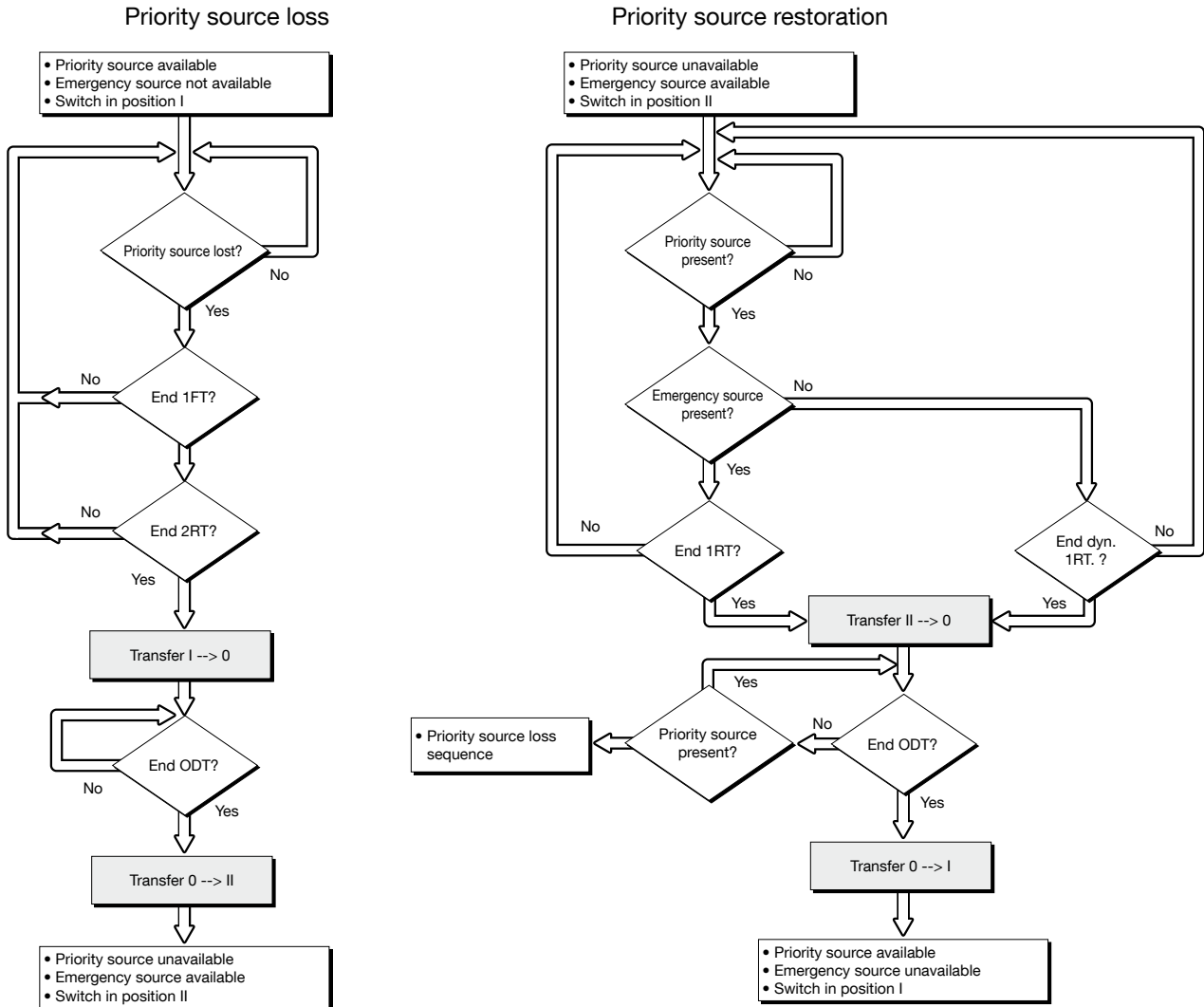



### 13.6.5. Priority source loss sequence (with trip) in M-M application

#### Configuration

- APP = M-M: Mains - Mains application
- RETURN 0 = YES: : the changeover switch switches to position 0 (open) during loss of the source

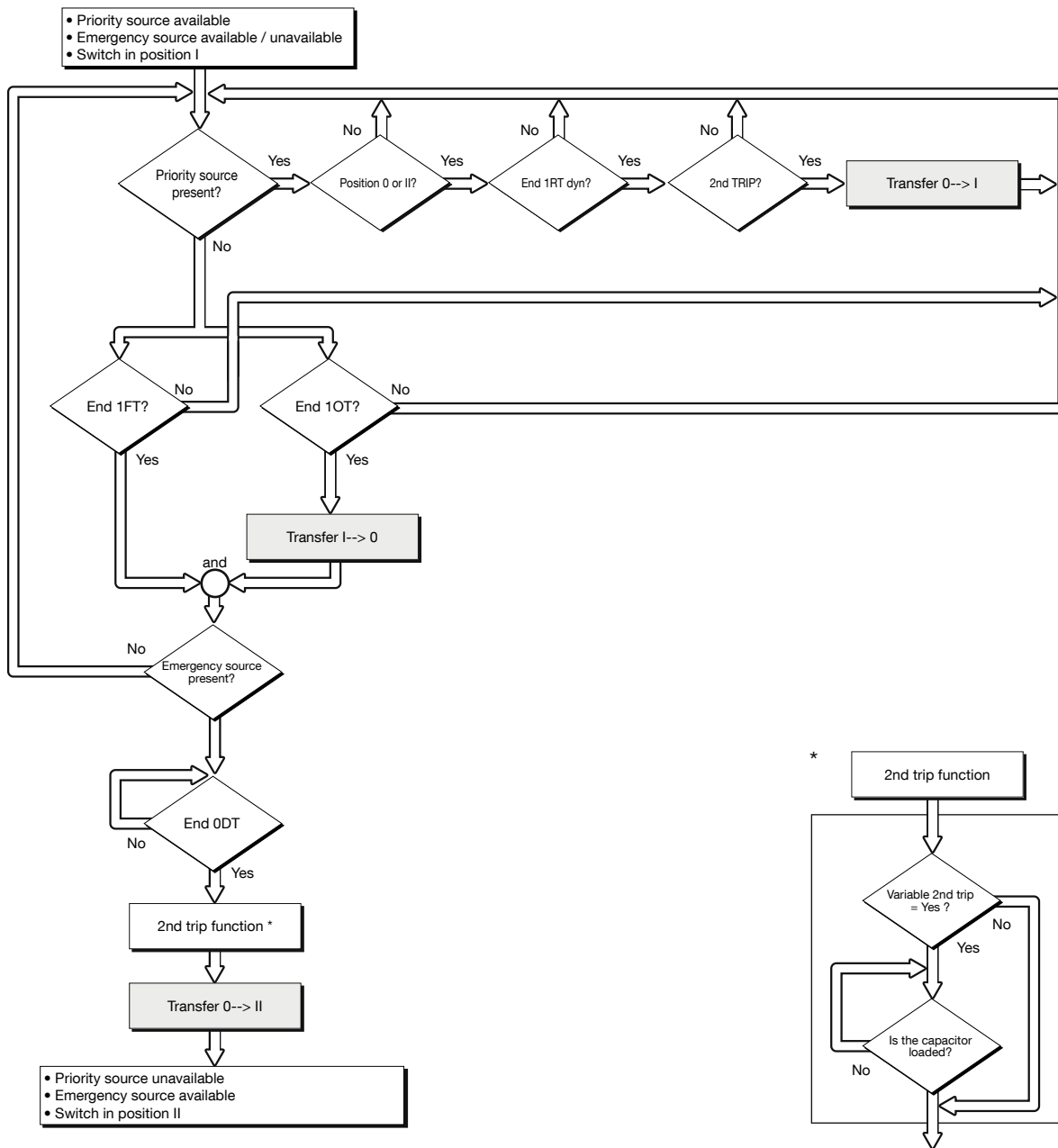

### 13.6.6. Priority source loss sequence (with trip) in M-G application

#### Configuration

- APP = M-G: Mains - genset application
- RETURN 0 = YES: : the changeover switch switches to position 0 (open) during loss of the source

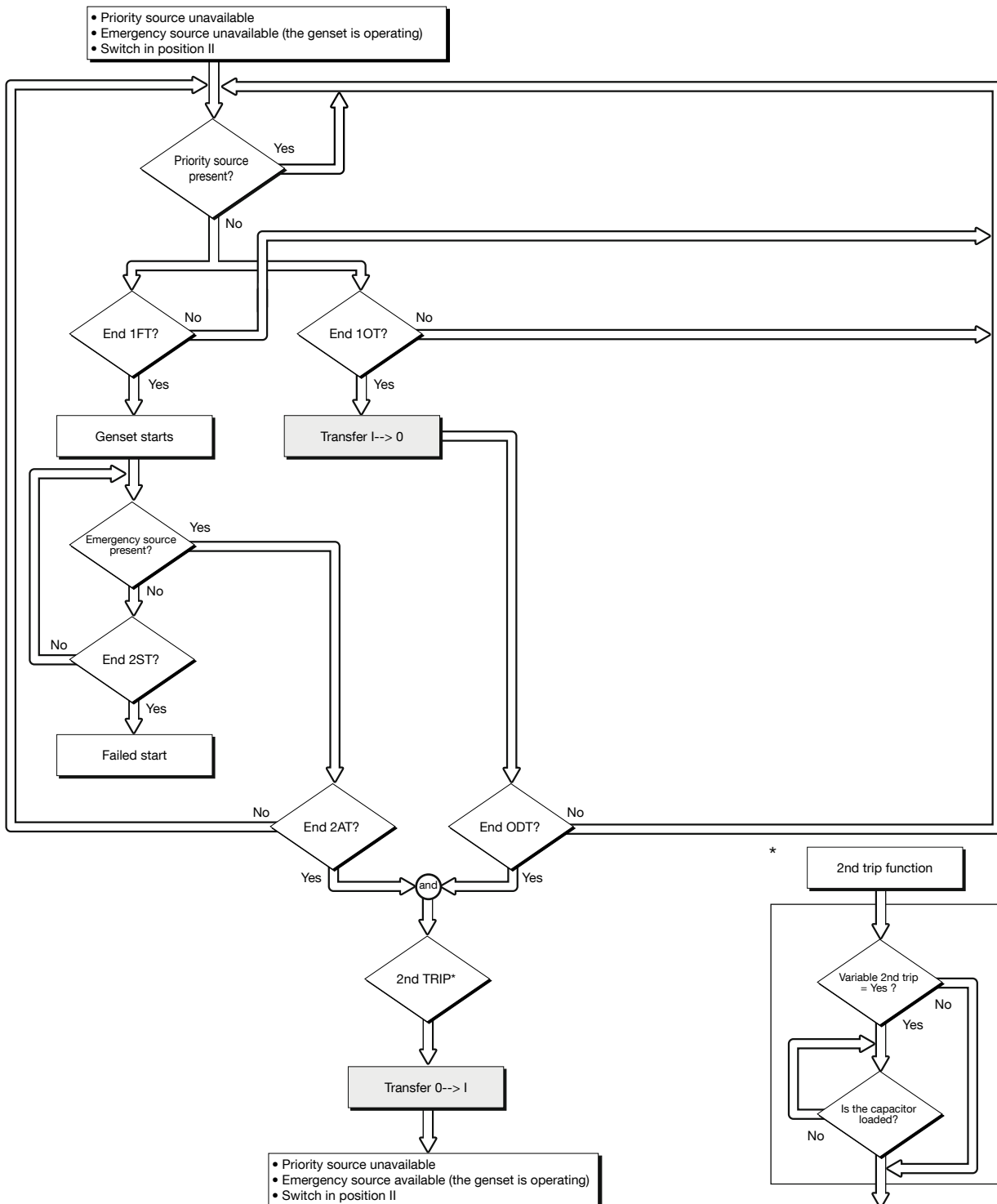

### 13.6.7. Priority source automatic restoration sequence

This sequence is started as soon as the system is in AUTO mode and in position II.

- Specific function

Automatic retransfer inhibited:

- Once source I is restored, it may be preferable not to retransfer the load from source II to source I immediately.
- Once the retransfer from source II to source I is possible, the RETRANS function locks the retransfer, and the AUT LED flashes pending the operator's confirmation.
- The VALIDATION button must be pressed or an input programmed on RTC to authorise the retransfer.

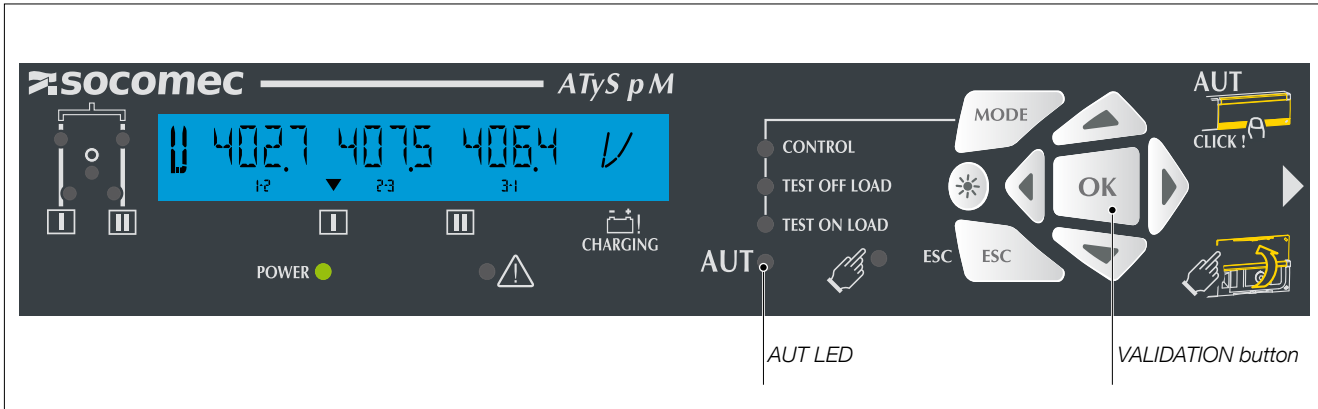

### 13.6.8. Priority source restoration sequence (stable position) in M-G application

#### Configuration

- APP = M-G: Mains - genset application
- RETURN 0 = NO: changeover switch remains in closed position during loss of the source

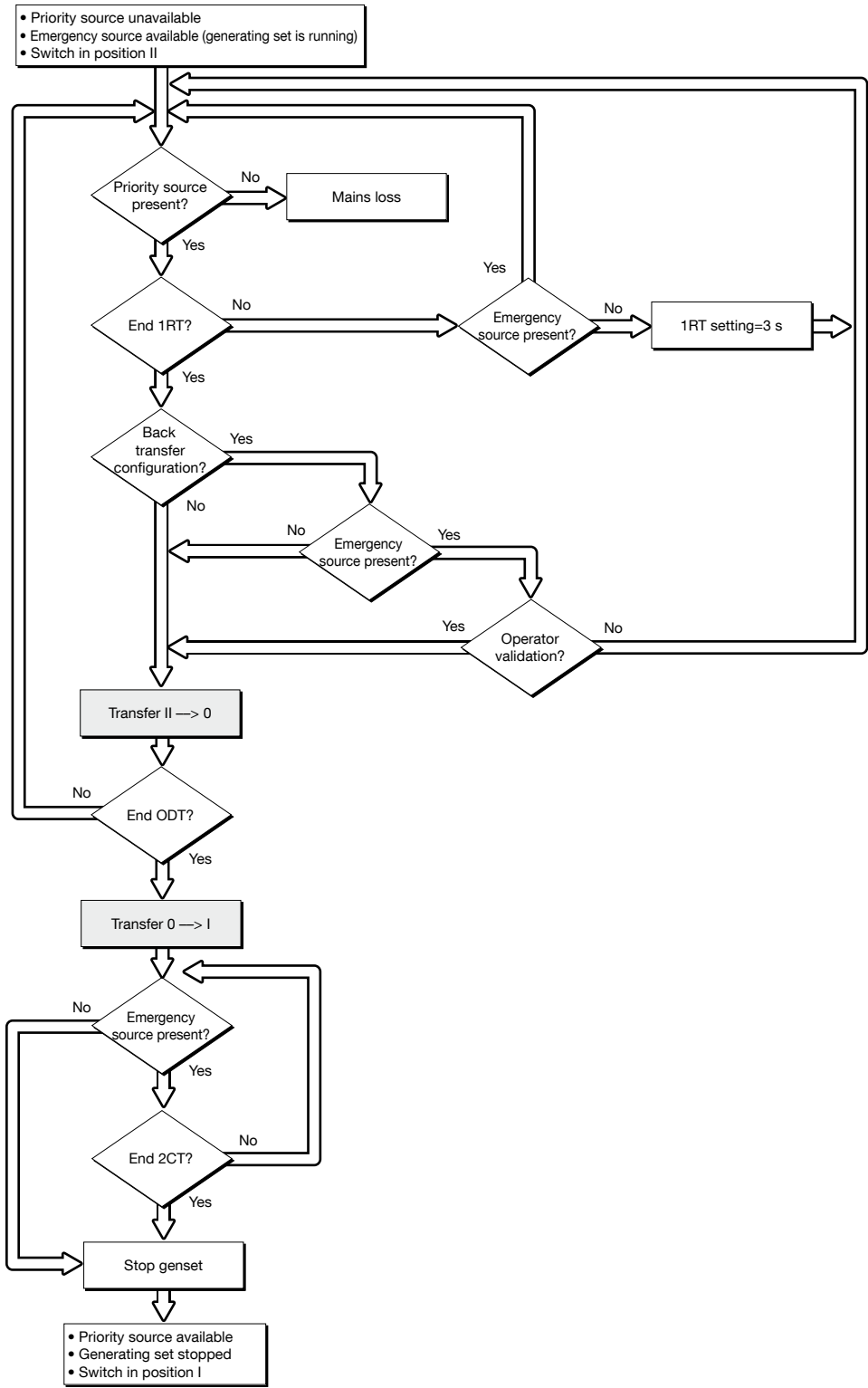

### 13.6.9. Back-up source loss sequence (with trip) in M-G application

#### Configuration

- APP = M-G : Mains - genset application
- RETURN 0 = YES: : the changeover switch switches to position 0 (open) during loss of the source

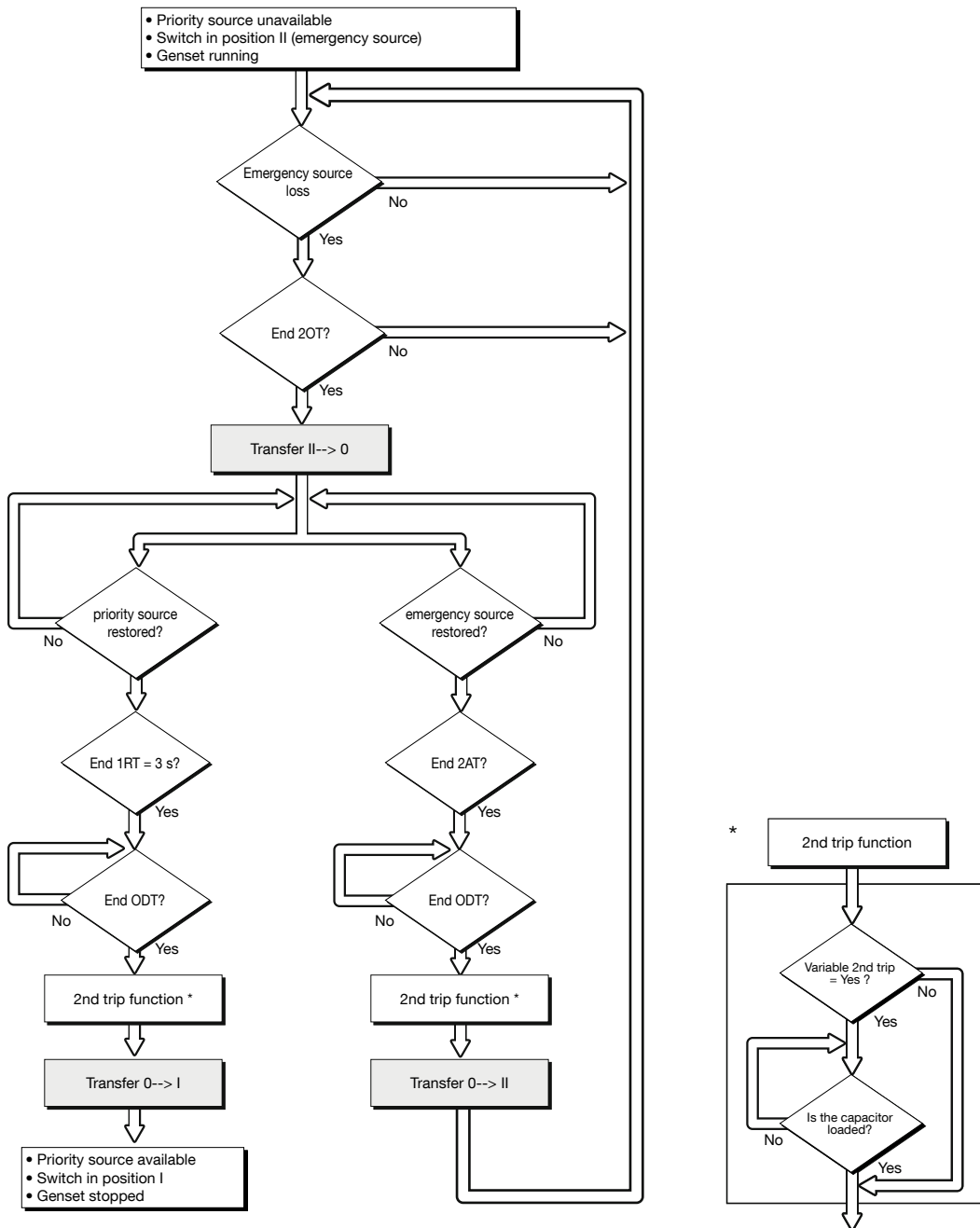

## 13.7. Control / Test operating mode

In this mode the operator has the option of controlling the transfer manually or electrically. Test modes are also available.

### 13.7.1. Test modes

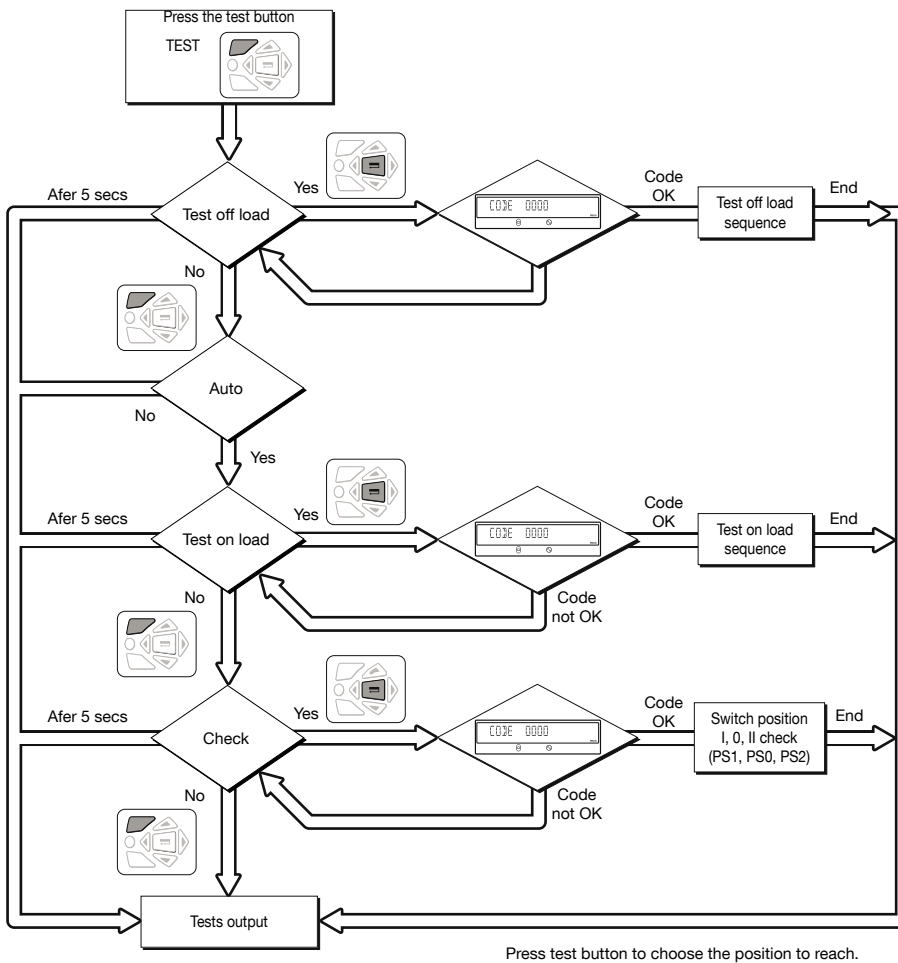

### 13.7.2. Off load test (M-G application only)

This test is possible in automatic or manual mode. It can be considered as a manual genset starting order without switching over the load to the genset.

#### Description

- This mode enables you to test the genset without load transfer.
- The genset is started and stopped as normal (via the «Gen set start» contact output 73-74) on operator order.
- This test is always possible, except during a source loss sequence , which is a condition for the test to be stopped.
- The test duration can be programmed (TFT time delay).

#### Activation

- either on the local HMI, via the test modes,
- or via the D20 interface,
- or via the programmable input,
- or via communication (for version with COM).

## Deactivation

- either by changing the status of the control input,
- or by pressing the validation key on the product keypad or D20,
- or after a genset starting timeout,
- or at the end of the timer (if set),
- or if the source I is lost,
- or in case of genset shutdown upon fault.

### 13.7.2.1. On load test (M-G application only)

This test is only possible in automatic mode, it enables you to start the genset and simulate a complete transfer sequence.

## Description

- The purpose of this sequence is to execute a load transfer to the genset to test it, while adhering to switchover conditions.
- The time delays for validating the transfer conditions (TOT, 2ST, 2AT, 0DT, 2CT) are derived according to their configuration.
- The “retransfer confirmation” function is always active throughout an on load test. It enables transfer back to source I in case of an unlimited on load test, or interrupts a time delayed on load test.

## Activation

- either via the operating menu,
- or via the D20 interface,
- or via the programmable input,
- or via communication (for version with COM).

## Deactivation

- either by changing the status of the control input
- or by pressing the validation key on the product keypad or D20
- or after a genset starting timeout
- or at the end of the timer (if set)
- or in case of genset shutdown upon fault

### 13.7.2.2. Changeover switch position I, 0 and II check (accessible in AUT mode)

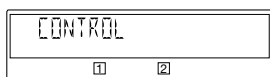

## Description

Electrical operation of the changeover switch to reach position: PS1, PS0, PS2.

## Activation

- either via the operating menu. It will then be possible to force one of the positions I, O, II via the keypad,
- or via the D20 interface,
- or via the programmable input,
- or by via communication (for version with COM).

## Deactivation

- either via the Escape key
- or by switching from Auto mode to Man. mode.



The control takes priority over all functions.

## 13.8. Emergency breaking (trip function)

The emergency breaking (trip) function ensures the following:

- on-load breaking,
- breaking across all live conductors.

The product must be configured and wired as follows to allow emergency breaking:

Menu	Parameters	Setting
SETUP	2ND TRIP	YES
I-O	IN1	FT1
I-O	IN1	NO
I-O	IN2	RST
I-O	IN2	NO

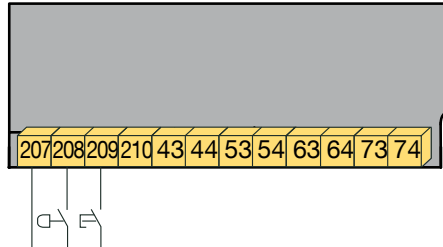

Following an emergency trip, the fault must be validated and inhibited to allow the resumption of automatic operation (by opening then closing the Auto-Man cover, activating the RST input or via the RS485).

The solution shown above enables resetting via activation of the RST input.



## 13.9. Communication (optional 9383 xxxx units only)

### 13.9.1. COMM Menu

Variable	Definition	Adjustment range	Default value
Address	Address of the device	1 to 255	5
Speed	Communication speed	2400, 4800 9600, 19200 38400	9600
Stop bit		1, 2	1
Parity		NO, ODD, EVE	NO



Only available on ATyS p M version with Comm.

RS485	2 or 3 wire half-duplex
Protocol	MODBUS® protocol in RTU Mode
Speed	2400, 4800, 9600, 19,200, 38,400 Bauds
Galvanic insulation	2.5 kV (1 min 50 Hz)

### 13.9.2. General Information

Communication via an RS485 connection (Modbus® protocol) enables you to connect up to 31 ATyS to a PC or a programmable logic controller over a distance of 1200 metres.

#### • Recommendations

You should use a shielded twisted pair (LIYCY type).

If the distance of 1200 m and / or the number of 31 ATyS is exceeded, it is necessary to connect a repeater to enable an additional connection of ATyS over more than 1200 m. For further information on the connection methodology, please consult us.

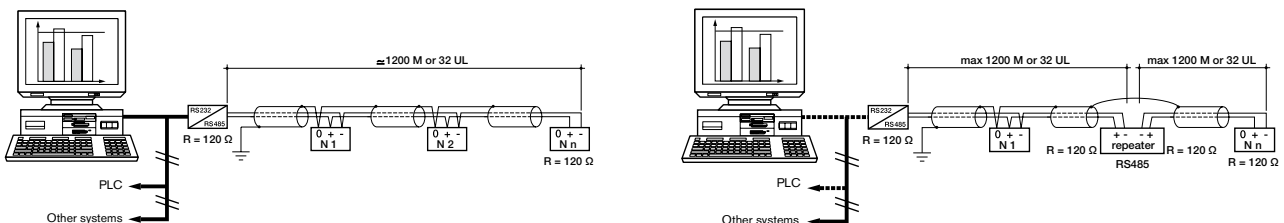

It is essential to have a 120 ohm termination at both ends of the bus. This termination is selectable on the ATyS p M close to the RS485 connection terminal.

### 13.9.3. Modbus® protocol

The Modbus® protocol used by the ATyS requires a dialogue using a master/slave hierarchical structure. Two dialogues are possible:

- the master communicates with a slave (ATyS) and waits for its reply,
- the master communicates with all the slaves (ATyS) without waiting for their reply.

The mode of communication is the RTU (Remote Terminal Unit) using hexadecimal characters of at least 8 bits. In the communication protocol, a standard frame is made up of the following elements:



- Slave address: Communicating device address (Add, menu Comm parameters)
- Function code: the codes which can be used are as follows:
  - 3 : to read n words (maximum 125)
  - 6 : to write one word
  - 16 : to write n words (maximum 125).
- Address : Register address (refer to following tables)
- Data : Parameters linked to function (number of words, value)

When slave address 0 is selected, a message is sent to all devices present on the network (only for functions 6 and 16); this type of message is called general distribution, so it is not followed up with a response from the slaves.

The maximum response time (timeout) is 250 ms between a question and a response.

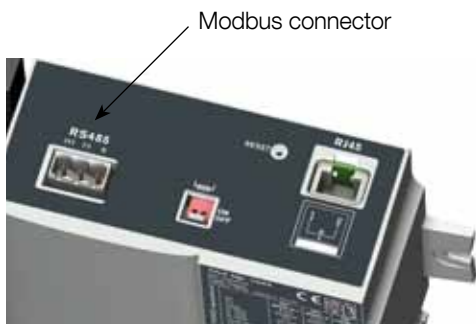

### 13.9.4. Function 3

Dec. address.	Hex. address.	No. of words	Designation	Unit
Status				
20480	5000	1	Type of network 1: 127 - 230 V 2: 230 - 400 V	
20481	5001	1	Operating mode 0x0000: Manual mode                      0x0020: Control mode 0x0010: Automatic mode                0x0040: Inhibited mode	
20482	5002	1	Position 1: Position 0 2: Position I 3: Position II	
20484	5004	1	Genset starting order status, source <span style="border: 1px solid black; padding: 0 2px;">II</span> 0: Inactive 1: Active	
20485	5005	1	Priority 0: Network 1: Source <span style="border: 1px solid black; padding: 0 2px;">I</span> 2: Source <span style="border: 1px solid black; padding: 0 2px;">II</span>	
20486	5006	1	Source <span style="border: 1px solid black; padding: 0 2px;">I</span> status 0: No source 1: Out of thresholds 2: Available	
20487	5007	1	Source <span style="border: 1px solid black; padding: 0 2px;">II</span> status 0: No source 1: Out of thresholds 2: Available	
20488	5008	1	Test in progress 0x0000: None                                0x0004: TON 0x0001: TOF                                0x0008: EON 0x0002: EOF	
20489	5009	1	Cycle counter	
20490	500A	1	Operations to position I counter	
20491	500B	1	Operations to position II counter	
20492	500C	1	Fault signal 0: None 1: Alarm 2: Fault	
20493	500D	1	Alarm / fault code 0: None                                        8: F23 ROT - 2 1: F00 Op Fct                                9: F14 CAP - 1 2: F03 Neutral                               10: F24 CAP - 2 3: F11 FLT - 1                               11: F15 PWR - 1 4: F21 FLT - 2                               12: F25 PWR - 2 5: F12 ALR - 1                               13: F16 POS - 1 6: F22 ALR - 2                               14: F26 POS - 2 7: F13 ROT - 1                               15: F06 POS - 0	
20494	500E	1	Cause of last switchover 0: None                                        7: Source under-frequency <span style="border: 1px solid black; padding: 0 2px;">II</span> 1: Manual                                      8: Source over-frequency <span style="border: 1px solid black; padding: 0 2px;">I</span> 2: under-voltage <span style="border: 1px solid black; padding: 0 2px;">I</span> 9: Source over-frequency <span style="border: 1px solid black; padding: 0 2px;">II</span> 3: under-voltage <span style="border: 1px solid black; padding: 0 2px;">II</span> 10: Source phases unbalanced <span style="border: 1px solid black; padding: 0 2px;">I</span> 4: Overvoltage source <span style="border: 1px solid black; padding: 0 2px;">I</span> 11: Source <span style="border: 1px solid black; padding: 0 2px;">II</span> 5: Overvoltage source <span style="border: 1px solid black; padding: 0 2px;">II</span> 12: Direction of rotation inverted on source 6: Source under-frequency <span style="border: 1px solid black; padding: 0 2px;">I</span> <span style="border: 1px solid black; padding: 0 2px;">I</span> 13: Direction of rotation inverted on source <span style="border: 1px solid black; padding: 0 2px;">II</span>	

Dec. address.	Hex. address.	No. of words	Designation	Unit
<b>Load</b>				
20736	5100	1	Phase-phase voltage U12	V/100
20737	5101	1	Phase-phase voltage U23	V/100
20738	5102	1	Phase-phase voltage U31	V/100
20739	5103	1	Phase 1 neutral voltage, V1	V/100
20740	5104	1	Phase 2 neutral voltage, V2	V/100
20741	5105	1	Phase 3 neutral voltage, V3	V/100
20742	5106	1	Frequency Fr	Hz/100
<b>Source</b>				
20743	5107	1	Source <b>I</b> : Phase-phase voltage U12	V/100
20744	5108	1	Source <b>I</b> : Phase-phase voltage U23	V/100
20745	5109	1	Source <b>I</b> : Phase-phase voltage U31	V/100
20746	510A	1	Source <b>I</b> : Phase 1 neutral voltage (V1)	V/100
20747	510B	1	Source <b>I</b> : Phase 2 neutral voltage (V2)	V/100
20748	510C	1	Source <b>I</b> : Phase 3-neutral voltage (V3)	V/100
20749	510D	1	Source <b>I</b> : Frequency	Hz/100
20750	510E	1	Source <b>II</b> : Phase-phase voltage U12	V/100
20751	510F	1	Source <b>II</b> : Phase-phase voltage U23	V/100
20752	5110	1	Source <b>II</b> : Phase-phase voltage U31	V/100
20753	5111	1	Source <b>II</b> : Phase 1 neutral voltage (V1)	V/100
20754	5112	1	Source <b>II</b> : Phase 2 neutral voltage (V2)	V/100
20755	5113	1	Source <b>II</b> : Phase 3-neutral voltage (V3)	V/100
20756	5114	1	Source <b>II</b> : Frequency	Hz/100

<b>Time delays</b>				
20992	5200	1	Source <b>I</b> loss: 1FT	S
20993	5201	1	Source <b>I</b> return: 1RT	S
20995	5203	1	Source <b>I</b> return to 0: 1OT	S
20999	5207	1	Source <b>II</b> loss: 2FT	S
21000	5208	1	Source <b>II</b> return: 2RT (Appli M-M) or Source <b>II</b> Stabilisation: 2AT (Appli M-G)	S
21001	5209	1	Source <b>II</b> request maintained: 2CT	S
21002	520A	1	Source <b>II</b> return to 0: 2OT	S
21003	520B	1	Source <b>II</b> starting timeout: 2ST	S
21004	520C	1	Programmed genset starting following its last stop: EET	h
21006	520E	1	Time without electricity: 0DT	S
21007	520F	1	Load shedding timer: LST	S
21008	5210	1	Test Off Load duration timer: TFT	S
21009	5211	1	Test On load duration timer TOT	S
21010	5212	1	On Load external operation request timer (start): E1T	S
21011	5213	1	On Load external operation request timer (end): E3T	S
21012	5214	1	On Load external operation request timer (duration): E2T	S
21013	5215	1	Off Load external operation request timer (start): E5T	S
21014	5216	1	Off Load external operation request timer (duration): E7T	S
21015	5217	1	Off Load external operation request timer (duration): E6T	S

### 13.9.5. Function 6

Dec. address.	Hex. address.	No. of words	Designation	Unit
Control				
21584	5450	1	Command configuration 0x01: Configure RTE (Back transfer) 0x02: Cancel TOF (Off Load Test) 0x03: Configure TOF (Off Load Test) 0x04: Configure TON (On Load Test) 0x05: Configure EOF (External Off Load) 0x06: Configure EON (External On Load) 0x07: Cancel EOF (External Off Load) 0x08: Cancel EON (External On Load) 0x10: Cancel alarms and faults 0x11: Configure FT1 0x12: Configure FT2 0x13: Configure AL1 0x14: Configure AL2	
21585	5451	1	Operating mode configuration 3: Auto 4: Inhibit 5: Control Other: Unchanged	
21586	5452	1	Priority configuration 0: Network 1: Source <span style="border: 1px solid black; padding: 0 2px;">I</span> 2: Source <span style="border: 1px solid black; padding: 0 2px;">II</span> Other: Unchanged	
21587	5453	1	Position configuration Only available in test mode (address 5451 = 5) 0: None 1: Position 0 2: Position I 3: Position II	

### 13.9.6. Functions 3, 6 and 16

Dec. address.	Hex. address.	No. of words	Designation	Unit
Time delay configuration				
21760	5500	1	Loss of source <span style="border: 1px solid black; padding: 0 2px;">I</span> : 1FT	S
21761	5501	1	Source <span style="border: 1px solid black; padding: 0 2px;">I</span> return: 1RT	S
21763	5503	1	Source <span style="border: 1px solid black; padding: 0 2px;">I</span> return to 0: 1OT	S
21765	5505	1	Source <span style="border: 1px solid black; padding: 0 2px;">II</span> loss: 2FT	S
21766	5506	1	Source <span style="border: 1px solid black; padding: 0 2px;">II</span> return: 2RT (Appli M-M) or Source <span style="border: 1px solid black; padding: 0 2px;">II</span> stabilisation: 2AT (Appli M-G)	S
21767	5507	1	Source <span style="border: 1px solid black; padding: 0 2px;">II</span> request maintained: 2CT	S
21768	5508	1	Source <span style="border: 1px solid black; padding: 0 2px;">II</span> return to 0: 2OT	S
21769	5509	1	Source <span style="border: 1px solid black; padding: 0 2px;">II</span> starting timeout: 2ST	S
21770	550A	1	Time without electricity: ODT	S
21771	550B	1	0: TOT limited - 1: TOT unlimited	S
21772	550C	1	Test On Load duration timer: TOT	S
21773	550D	1	0: TFT limited - 1: TFT unlimited	
21774	550E	1	Test Off Load duration timer: TFT	S
21775	550F	1	0: E2T limited - 1: E2T unlimited	S
21776	5510	1	On Load external operation request timer (start): E1T	S
21777	5511	1	On Load external operation request timer (end): E3T	S
21778	5512	1	On Load external operation request timer (duration): E2T	S
21779	5513	1	Off Load external operation request timer (start): E5T	S
21780	5514	1	Off Load external operation request timer (end): E7T	S
21781	5515	1	Off Load external operation request timer (duration): E6T	S
21782	5516	1	Load shedding timer: LST	S
Threshold configurations				
21840	5550	1	Source <span style="border: 1px solid black; padding: 0 2px;">I</span> : Voltage upper threshold	
21841	5551	1	Source <span style="border: 1px solid black; padding: 0 2px;">I</span> : Voltage upper threshold hysteresis	
21842	5552	1	Source <span style="border: 1px solid black; padding: 0 2px;">I</span> : Voltage lower threshold	
21843	5553	1	Source <span style="border: 1px solid black; padding: 0 2px;">I</span> : Voltage lower threshold hysteresis	
21844	5554	1	Source <span style="border: 1px solid black; padding: 0 2px;">II</span> : Voltage upper threshold	
21845	5555	1	Source <span style="border: 1px solid black; padding: 0 2px;">II</span> : Voltage upper threshold hysteresis	
21846	5556	1	Source <span style="border: 1px solid black; padding: 0 2px;">II</span> : Voltage lower threshold	
21847	5557	1	Source <span style="border: 1px solid black; padding: 0 2px;">II</span> : Voltage lower threshold hysteresis	
21848	5558	1	Source <span style="border: 1px solid black; padding: 0 2px;">I</span> : Phase unbalance threshold	
21849	5559	1	Source <span style="border: 1px solid black; padding: 0 2px;">I</span> : Phase unbalance threshold hysteresis	
21850	555A	1	Source <span style="border: 1px solid black; padding: 0 2px;">II</span> : Phase unbalance threshold	
21851	555B	1	Source <span style="border: 1px solid black; padding: 0 2px;">II</span> : Phase unbalance threshold hysteresis	
21852	555C	1	Source <span style="border: 1px solid black; padding: 0 2px;">I</span> : Frequency upper threshold	
21853	555D	1	Source <span style="border: 1px solid black; padding: 0 2px;">I</span> : Frequency upper threshold hysteresis	
21854	555E	1	Source <span style="border: 1px solid black; padding: 0 2px;">I</span> : Frequency lower threshold	
21855	555F	1	Source <span style="border: 1px solid black; padding: 0 2px;">I</span> : Frequency lower threshold hysteresis	
21856	5560	1	Source <span style="border: 1px solid black; padding: 0 2px;">II</span> : Frequency upper threshold	
21857	5561	1	Source <span style="border: 1px solid black; padding: 0 2px;">II</span> : Frequency upper threshold hysteresis	
21858	5562	1	Source <span style="border: 1px solid black; padding: 0 2px;">II</span> : Frequency lower threshold	
21859	5563	1	Source <span style="border: 1px solid black; padding: 0 2px;">II</span> : Frequency lower threshold hysteresis	

Dec. address.	Hex. address.	No. of words	Designation	Unit
<b>Network configuration</b>				
22096	5650	1	Type of network 0: 4NBL (230/400V)                      5: 4NBL (127/230V) 1: 1BL (230/400V)                      6: 3NBL (127/230V) 2: 41NBL (230/400V)                  7: 2NBL (127/230V) 3: 42NBL (230/400V)                  8: 2BL (127/230V) 4: 3NBL (230/400V)                  9: 42NBL (127/230V)	
22097	5651	1	Neutral (0) AUTO                      1: neutral on the left                  2: Neutral on the right	
22098	5652	1	Direction of phase rotation 0: Undefined    1: ABC                  2: ACB	
22099	5653	1	Rated voltage 180 <= Unom <= 480	
22100	5654	1	Rated frequency 0: 50Hz                  1: 60 Hz	
22101	5655	1	Application type: 0: Network - Network (M-M)    1: Network - genset (M-G)	
22103	5657	1	Genset starting relay 0: NO                  1: NC	
22104	5658	1	PRIO NET 0: none                  1: source <input type="checkbox"/> I    2: Source <input type="checkbox"/> II	
22105	5659	1	PRIO TON 0: NO                  1: YES	
22106	565A	1	PRIO EON 0: NO                  1: YES	
22107	565B	1	RETRANS 0: NO                  1: YES	
22108	565C	1	RETURN O 0: NO                  1: YES	
22110	565E	1	2ND TRIP 0: NO                  1: YES	
22111	565F	1	MOD AUT 0: NO                  1: YES	
22112	5660	1	BACKLIGHT 0: OFF                  1: ON                  2: INT	

<b>Inputs / outputs configuration</b>				
22352	5750	1	Function IN 1 0: /	
22353	5751	1	Function IN 2 0: /	
22354	5752	1	Function IN 3 0: /	
22355	5753	1	IN 1 status 0: NO 1: NC	
22356	5754	1	IN 2 status 0: NO 1: NC	
22357	5755	1	IN 3 status 0: NO    1: NC	
22358	5756	1	Function OUT 1 0: /	
22359	5757	1	Function OUT 2 0: /	
22360	5758	1	Function OUT 3 0: /	

Inputs	Outputs
1: INH	1: S1A
2: tol	2: S2A
3: TOF	3: SCA
4: EON	4: AC1
5: EOF	5: AC2
6: MSR	6: AC0
7: RTC	7: LO1
8: PRI	8: LO2
9: SS1	9: LSC
10: SS2	10: FLT
11: PS1	11: POP
12: PS2	12: CP1
13: PS0	13: CP2
14: AL1	14: CP3
15: AL2	
16: FT1	
17: FT2	
18: OA1	
19: OA2	
20: RST	
21: LSI	



## 14. PREVENTATIVE MAINTENANCE

It is recommended to operate the product at least once a year.

I - O - II - O - I

Note: Maintenance should be planned carefully and carried out by qualified and authorised personnel. Consideration of the critical level and application where the product is installed should form an essential and integral part of the maintenance plan. Good engineering practice is imperative whilst all necessary precautions must be taken to ensure that the intervention (whether directly or indirectly) remains safe in all aspects.



The use of any Megohmmeter is prohibited on this product as the connection terminals are intrinsically connected to the sensing circuit.

# 15. TROUBLESHOOTING GUIDE

The ATyS p M includes event reporting that can be very useful to verify before troubleshooting. Refer to section «13.4.4. Events», page 35.

Symptoms	Actions to be carried out	Expected results
The product is not functioning	Check for a voltage of 106 to 305 Vac on the supply terminals: <i>Model 230/400 Vac:</i> - Terminals 1-7 corresponding to the Priority Source - Terminals 1-7 corresponding to the Emergency Source	The "POWER" LED is lit and the display is operational
The "Priority SOURCE Availability" LED does not come on	Press the "LED test" button	All the LEDs and the display illuminate
	Check whether the message "F13 ROT-1" is shown on the display (Priority Source Phase Rotation Fault). If this message appears, check for phase rotation consistency (or conventional direction) between the source and the ROT parameter in the SETUP menu, or between the 2 sources.	The "Priority SOURCE Availability" LED is lit
	Check the following parameters in the SETUP menu (programming mode): - the type of network => 230/400 Vac version: NETWORK: 4NBL, 41NBL, 42NBL, 1BL, 3NBL => 127/230 Vac version: NETWORK: 4NBL, 3NBL, 2NBL, 2BL, 42NBL - Nominal voltage => Un: measure at the cage terminals using a multimeter - Frequency => Fn: 50 or 60 Hz Check the voltage and frequency thresholds and hysteresis in the VOLT LEVELS and FREQ LEVELS menus	
If using an Auto transformer - proceed as follows: - Step 1: Enter programming mode - Step 2: In the SETUP menu, configure the NETWORK parameter to 3NBL. - Step 3: In the SETUP menu, configure the NEUTRAL parameter (location of Neutral) to left or right depending on where the neutral is connected. - Step 4: Exit programming mode		
The "Emergency SOURCE Availability" LED does not come on	Press the "LED test" button	The "Emergency SOURCE Availability" LED is lit
	Check whether the message "F23 ROT- 2" is shown on the display (Emergency Source Phase Rotation Fault). If this message appears, check for phase rotation consistency (or conventional direction) between the source and the ROT parameter in the SETUP menu, or between the 2 sources.	
	CAUTION: a Generator operating off load can generate a Fr and a U lower than the nominal values: - Check the nominal voltage threshold and hysteresis in the VOLT LEVELS menu - Check the frequency threshold and hysteresis in the FREQ LEVELS menu	
	Check the following parameters in the SETUP menu (programming mode): - the type of network => 230/400 Vac version: NETWORK: 4NBL, 41NBL, 42NBL, 1BL, 3NBL - Nominal voltage => Un: measure at the cage terminals using a multimeter - Frequency => Fn: 50 or 60 Hz	
	If using an Auto transformer - proceed as follows: - Step 1: Enter programming mode - Step 2: In the SETUP menu, configure the NETWORK parameter to 3NBL. - Step 3: In the SETUP menu, configure the NEUTRAL parameter (location of Neutral) to left or right depending on where the neutral is connected. - Step 4: Exit programming mode	

Symptoms	Actions to be carried out	Expected results
The product remains switched off after the Priority SOURCE is lost	Check for a voltage of 106 to 305 Vac on the supply terminals: - Model 230/400 Vac: Terminals 1-7 corresponding to source II	The "POWER" LED is lit and the display is operational
	For a Transformer/Generator application Check that 1FT (1 Failure Timer) has counted down. - Use a stopwatch. - Start the stopwatch when the product has lost its Priority SOURCE. - If GE START = NO (Normally Open) in the SETUP menu: Contact 73-74 Closed = Generator starting order Contact 73-74 Open = Generator stoppage order - If GE START = NC (Normally Closed) in the SETUP menu: Contact 73-74 Closed = Generator stoppage order Contact 73-74 Open = Generator starting order	The Generator is operating The "POWER" LED is lit and the display is operational
The product does not switch over after the Priority SOURCE is lost	Check that the product is not in manual mode: - Automatic mode = Cover closed - Manual mode = Cover open	The "AUT" LED is lit
	Check that automatic operation has not been inhibited by external orders	
	Check the state of the "Emergency Source Availability" LED. If it is off, refer to the symptom concerned (higher in the list)	The "AUT" and "Emergency SOURCE Availability" LEDs are lit
The product does not switch over when the Priority SOURCE is restored	Check that the product is not in manual mode: - Automatic mode = Cover closed - Manual mode = Cover open	The "AUT" LED is lit
	Check that automatic operation has not been inhibited by external orders	
	Check the state of the "Priority Source Availability" LED. If it is off, refer to the symptom concerned (higher in the list)	The "AUT" and "Priority SOURCE Availability" LEDs are lit
	Check the setting of 1RT (1 Return Timer). If necessary, use a stopwatch to check the switch to Priority SOURCE. The duration of this delay is between 0 and 3600s	The display shows 1RT xxxSEC. At the end of the delay, the product switches over to mechanical position 0, then to Priority SOURCE
	Check that the "manual retransfer" function is not active (if this function is not required) - Go to the SETUP menu - Set RETRANS to NO	Message "RETRANS?" not displayed. The product should return automatically to the Priority SOURCE
Return to Priority SOURCE has been executed, but the Emergency Source (for a Generator) continues to operate	Check that 2CT (2 Cool Timer) counts down – Duration between 0 and 600s - Use a stopwatch. - Start the stopwatch when the product has switched over to the Priority SOURCE. - Contact 73 - 74 should change state once this delay has counted down - If GE START = NO (Normally Open) in the SETUP menu: Contact 73-74 Closed = Generator starting order Contact 73-74 Open = Generator stoppage order - If GE START = NC (Normally Closed) in the SETUP menu: Contact 73-74 Closed = Generator stoppage order Contact 73-74 Open = Generator starting order	The display shows 2CT xxxSEC. At the end of this delay, the Generator stops and the "Emergency SOURCE Availability" LED goes out
	Check that the product is not in Automatic mode: - Automatic mode = Cover closed - Manual mode = Cover open	The "AUT" LED is lit
	Check that automatic operation has not been inhibited by external orders	

Symptoms	Actions to be carried out	Expected results
ON LOAD and OFF LOAD tests cannot be started via the keypad	Check that the product is not in Automatic mode: - Automatic mode = Cover closed - Manual mode = Cover open	The "AUT" LED is lit
	Check that automatic operation has not been inhibited by external orders	
	Check the Operating mode password (factory code 0000) to access the test functions	The "TEST ON LOAD" or "TEST OFF LOAD" LED is lit, depending on the selected test mode
	Check that the product is in M-G application	The APP parameter should be M-G in the SETUP menu
	Check the state of the "Priority Source Availability" LED. If it is off, refer to the symptom concerned (higher in the list)	The "Priority SOURCE Availability" LED must be lit to allow these Tests to be run
The product cannot be switched over using the handle	Check the direction of rotation of the handle: - Manual switchover from position 1 to position 2 is executed clockwise - The return operation is executed anticlockwise	The product can be switched over using the handle
	Check that the product is not padlocked	
	Use the handle extension on the ALLEN key to check that the appropriate adjustment torque is applied.	
	When using a single AC, check that the length of the screws used is not greater than 20 mm	
AUTOMATIC mode is not activated even though the cover is closed	Check that the plastic pin (sensor) is in place on the bottom of the cover This pin activates the sensor which indicates the position of the cover (open or closed)	The "AUT" LED is lit
	Check that automatic operation has not been inhibited by external orders	
The product cannot be locked	Check the mechanical position of the changeover switch: - Locking is only possible in position 0 as standard - Locking in positions 1-0-2 is possible by modifying the product in accordance with the instructions	Locking is possible
The product is faulty	See listing «13.4.5. Events list», page 35.	The FAULT LED is off and the error message disappears



---

CORPORATE HQ CONTACT:  
SOCOMECSAS  
1-4 RUE DE WESTHOUSE  
67235 BENFELD, FRANCE

---

[www.socomec.com](http://www.socomec.com)



542 935 C - EN - 12/16

 **socomec**  
Innovative Power Solutions